

➤ Based on **experience**

Backed by commitment



x2000 Series AC Drive



x2000

L&T Electrical & Automation



WARNING
 Risk of Injury or Electric Shock.
 Read the manual and follow the safety
 instructions before install or use.
 Before opening the cover, disconnect
 all power and wait at least 10 minutes.



Contents

	Page
Flexi Series Fx2000	7
Smart Series Sx2000	17
Energy Saver HVAC Series Hx2000	27
New Series Nx2000⁺	43
New Series Nx2000	59
Smart Series Sx2000 IP66	63
Accessories	68
Peripheral Devices	71
Other Automation Products	74



The new **reliability** edge

x2000 | AC Drive Series

Over three decades of application knowledge

For over three decades, various industry sectors have been reaping the benefits of L&T Electrical & Automation (E&A)'s cost-effective, performance-oriented AC Drive solutions. E&A's grasp of the specific needs of each industry enables it to offer application-specific solutions for various industries — such as processing, textile, plastic, ceramic, pharmaceutical, elevator, oil & gas, power, cement and material-handling.



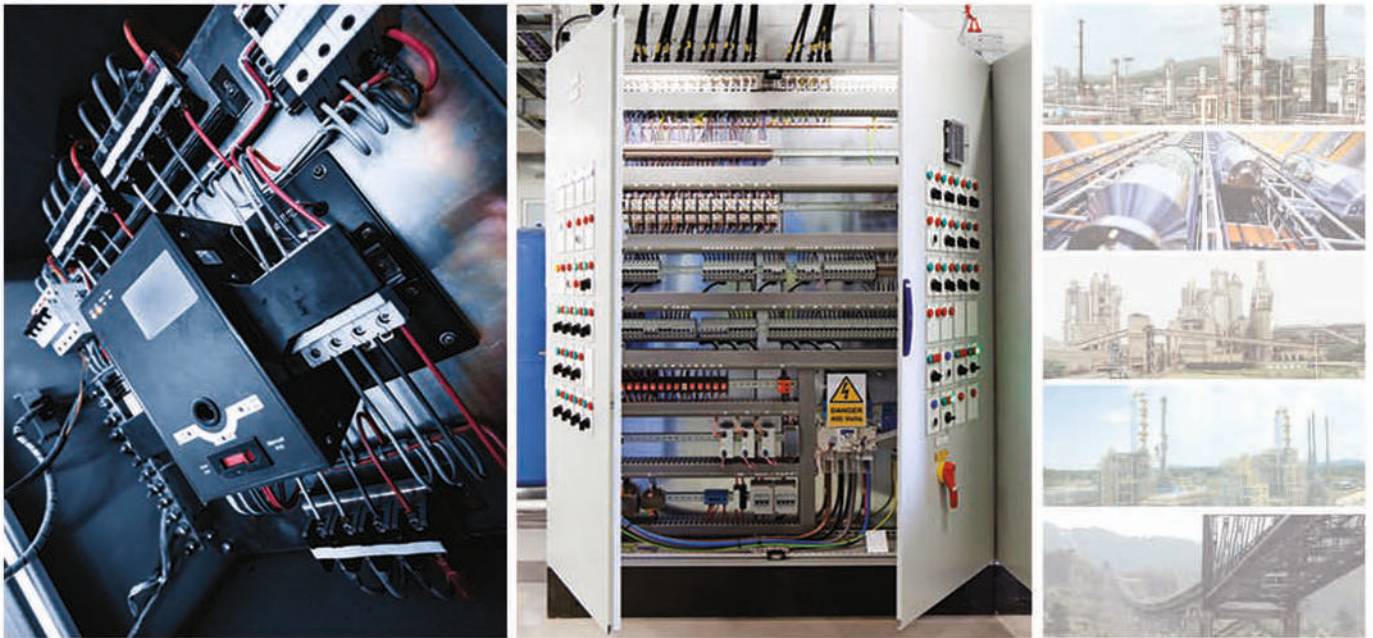

➤ **Backed** by engineering knowledge across seven decades

A knowledge-based company, L&T Electrical & Automation (E&A) brings you the benefits of its engineering experience and expertise, and the richness of its collaborations with technology leaders across the globe.

E&A's low-voltage switchgear – India's widest range – has been the preferred option of top industrial houses countrywide.



➤ **Tested. Certified. Reliable.**

E&A is one of the few switchgear manufacturers in India with a dedicated, NABL-certified testing facility. Our products are tested for conformity to standards that exceed mandatory requirements, giving you the assurance of high-quality performance. Our focus on continuous improvement ensures that our quality is on par with the best in the world. Repeat orders endorse the value that we deliver.

The reliability of the **x2000** series AC Drives is ensured by international test certification – UL, CE and RoHS.



› **After-sales service**
aimed at maximum uptime

A malfunction of the drive can bring an entire assembly line or process to a halt. To ensure maximum uptime for you, our Rapid Response service team is available to analyze the situation and help you set the problem right. We have set up strategic service centres across the country to provide temporary replacement drives or ready spares to ensure that your business keeps running smoothly.



› **Training your people**
to enhance your operations

At our countrywide Switchgear Training Centres, we can train your operators, electricians and supervisors to increase their effectiveness in the operation and maintenance and trouble-shooting of your drives. We can also conduct in-plant training and workshops at your premises to improve both power management and equipment maintenance skills. This gives you total operational excellence, minimising downtime.

E&A's engineers and channel partners also upgrade their skills through seminars, workshops, training sessions and white papers on electrical practices.



AC Drives

Salient Features	Advantages	Benefits
Built-in 24V Power Source	Reduced wiring & no need of external SMPS	No extra cost & space for SMPS & its mounting
Built-in potentiometer	No need of external potentiometer, possible to add reference from keypad and external signal	No extra expenditure of external potentiometer, simple panel wiring and no panel cut-out
Conformal Coating	Complies to IEC 60721-3-3 class 3C3. Improves life of electronic circuit in harsh environments, even reduces downtime	Increased life of drive
Booster Pump Control	Maintains desired pressure or flow by operating pumps run by conventional starters	Saving on cost of external controller
User Sequence (PLC Functionality)	It creates a simple sequence from a combination of different function blocks. No software required to create logic.	Saving on cost of external hardware or extra PLC
Multi Keypad	One master keypad can monitor/program 16 slave drives	Saving on cost of external display for slave drives
Peer-to-Peer Communication	Allows the drives to share any I/O via inbuilt RS485 communication	Saving on cost of external I/O expansion card
Sleep & Wake PID Function	Automatically switches OFF the drive during user-programmed low-load conditions and then to startup again when process demand increases	Energy-saving as well as saving on wear and tear of mechanical system
Brake Control	Provides external brake control function for vertical load such as crane & elevator	Improves safety
Pre PID	Performs a general acceleration until the set frequency is reached	Smooth PID operation
2nd Motor Operation	Single AC drive can maintain two motor parameters connected to two different loads, different accel / deaccl time, motor current & protection for both the motors	For isolated operation of motors one VFD can be used in place of two
Built-in Chopper	Ease of wiring, saves space	No external DBU required, hence reduced cost
Built-in DC Reactor	Reduced harmonics and improved power factor	No external reactor required
Built-in Safety Circuit	If a machine needs to stop in an emergency, circuit will block the drive output.	Additional human & machine safety
Removable Terminal Block	Control card of the existing drive can be replaced to new drive without removing control wiring	Reduces downtime for AC drive replacement
Component Life Monitoring	Digital output can be triggered when components eg. capacitor have completed their lifespan	Pre-alarm for capacitor failure, avoiding breakdown
Enhanced Cooling Design	Suction structure for internal cooling system enhances their protection and improves the life of drive in dusty working environment	Improves operating life of IGBT & AC drive
RS485 Modbus Communication	Ease of communication with 3rd party devices on MODBUS	No extra cost for RS485 Modbus
RoHS-compliant	Complies to EU Directive 2002/95/EC stands for restriction of hazardous substances	Lead-free products, environment-friendly
No Motor Detection	Drive trips when all the 3 phases are disconnected	Useful protection in overhauling applications running with external mechanical brake

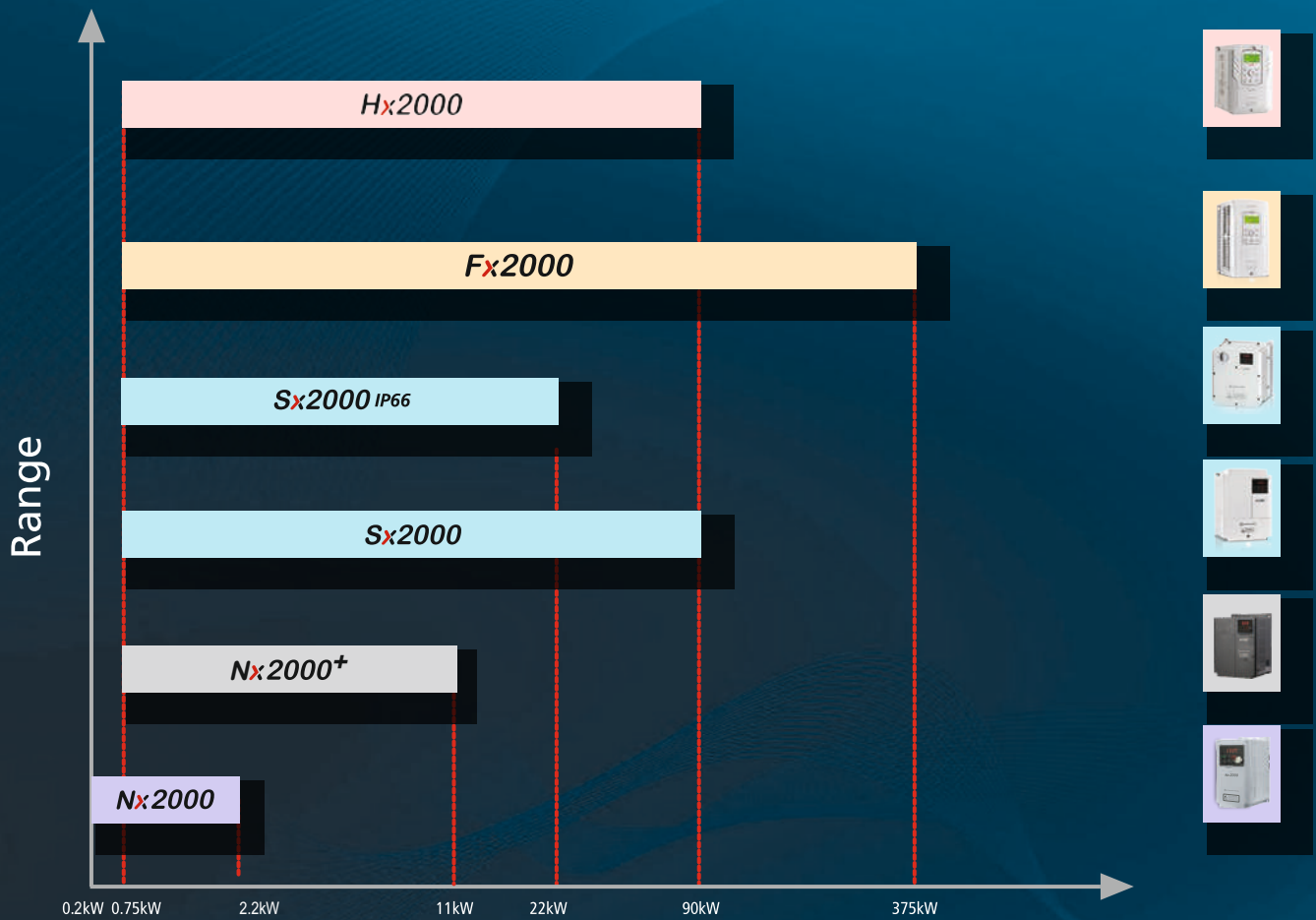

Nx2000: 1-Phase 230V 0.2 to 2.2kW (HD)	1-Phase 230V 0.75 to 3.7kW (ND)
Nx2000+: 3-Phase 230V 0.75 to 11kW (ND)	Sx2000: 3-Phase 230V 0.75 to 18.5kW (ND)
3-Phase 415V 0.75 to 11kW (ND)	3-Phase 415V 0.75 to 90kW (ND), 0.4 to 22kW (HD) - IP66
Fx2000: 3-Phase 415V 0.75 to 375kW (HD)	Hx2000: 3-Phase 415V 0.75 to 90kW (ND)

Model type & Selection:

LTVF	—	x	x	xxxx	x	x	A
L&T Electrical & Automation Variable Frequency Drive		Series	Input Voltage	Drive Current Rating (ND)*	Enclosure	Keypad	Reserved
		N Nx2000	1 Single-Phase 200~240[V]		A IP00	A With Keypad	
		S Sx2000	2 Three-Phase 200~240[V]		B IP20		
		F Fx2000	4 Three-Phase 380~480[V]		C IP21		
		H Hx2000			X IP66		

* For 230Vac Single-Phase & Sx2000 IP66 drive mentioned current is HD rating

Applications

x2000 Series Applications	Nx2000 & Nx2000 ⁺	Sx2000	Fx2000	Hx2000
Blowers	●	●	●	●
ID / FD Fan	●	●	●	
Pump	●	●	●	●
Conveyors	●	●	●	
Compressors	●	●	●	●
Crane Hoisting		●	●	
Crane Traverse	●	●	●	
HVAC	●	●		●
HVLS	●			
Agitator	●			
Lifts Door Control	●			
Lifts		●	●	
Escalators	●	●	●	
AHU	●	●		●
Winders		●	●	
Wire Drawing	●	●	●	
Ball Mill		●	●	
Textile Machinery	●	● [*]	●	
Centrifuge	●	●	●	
Extruder		●	●	
Spinning Machine	●	● [*]	●	
Rotary Klins			●	
Printing	●	●	●	
Crushers		●	●	
Hydraulic Press		●	●	
Plastic Machinery	●	●	●	
Food Packaging	●	● [*]	●	
Solar Pump		●		
Mixers	●	●	●	
Tank Rotator	●	●	●	
Pulper		●	●	
Tea Making	●	●	●	
Rubber Machinery		●	●	
Machine Tools	●	●	●	
Material Handling	●	●	●	

Note: Above chart is only a general guideline. Please contact us with exact details of your application.

*Sx2000 IP66 is best suitable for this application.

Fx2000



The Fx2000 generates powerful performance and meets your precise needs through several features: superior V/F control, V/F PG, slip compensation and sensorless vector control as well as closed-loop vector control.

The Fx2000 is perfectly suited for the toughest, most complex applications – cranes, plastic winders, high-speed elevators, cement kilns, crushers... and more. It handles loads up to 375 kW - HD / 450 kW - ND, and is engineered to keep your machine operating at optimum efficiency, even in the hot, humid and dusty conditions that characterize India's industrial environment.



› Main Features

- Range: 0.75kW to 375kW (HD)
- V/F control, V/F with PG, Slip compensation, Sensorless Vector Control, Close Loop Vector Control
- Built-in Macro for Crane
- Starting Torque: 250% at 0Hz for Closed Loop
- Optional Smart PLC
- Optional Synchronization card
- Droop Control
- Conformal Coating complying to IEC 60721-3-3 class 3C2 (max) and class 3C3 (avg)
- Built-in RS485 Modbus RTU Communication

› Applications

- Crane Hoist
- Crane Control LT / CT
- Winders
- Wire Drawing
- Plastic & Textile Machines
- Conveyors
- Compressors
- Extruders
- Fan
- Pump

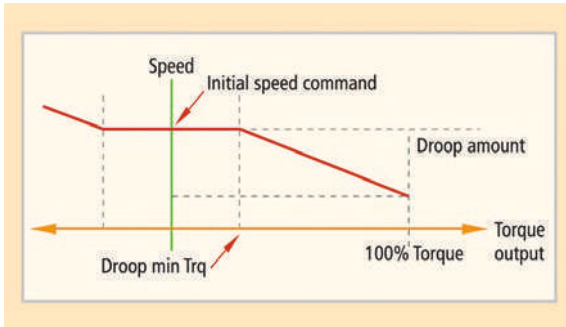

› Automatic Torque Balance droop control

Droop control algorithm adjusts changeable torque driven by speed. This algorithm is easily applicable to open-loop linking driving and load sharing driving.

› Ride-through (LV trip delay) for sudden power loss

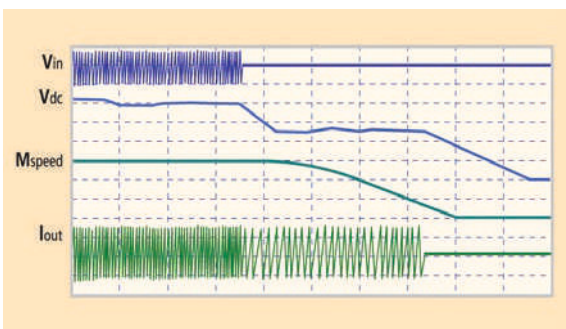
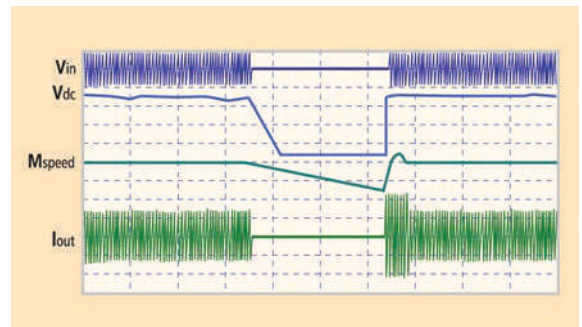

› Kinetic Energy Buffering (KEB) for a stable system stop in case of power loss or failure

› Closed Loop Vector realizing precise speed/torque control

In the entire speed range including zero speed, powerful torque (up to 250%) performance is materialized through receiving Max. 200kHz frequency pulse via an encoder-dedicated board.

- Speed control range 1000:1
- Instant Max. torque control capability 250%
- 50Hz speed control response

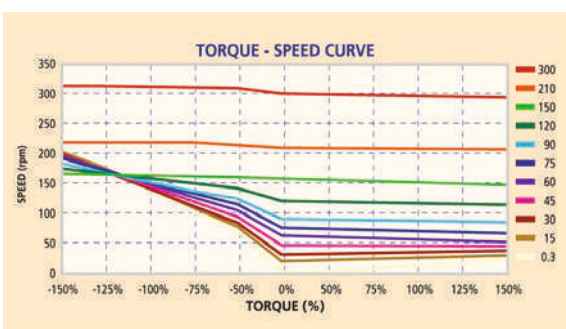
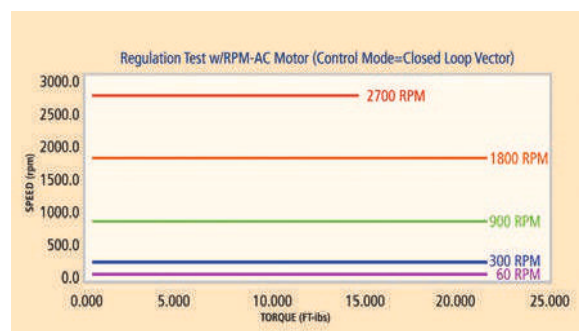

› Powerful current sensorless vector control

Our Fx2000 technology includes a competitive and strong low-speed torque control and a speed-precision-driven vector algorithm.

- Speed control range 100:1
- Extremely low torque control capability: 0.1Hz/150% real torque
- Max. torque control capability within the restoration range

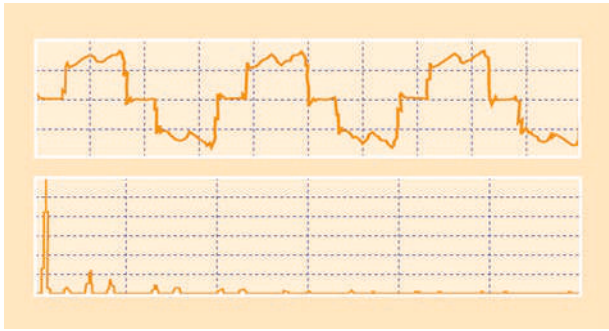

➤ **DC reactor built-in*** for harmonic reduction and power factor improvement

* From 22kW to 280kW (ND)

➤ **Multi-function key**

It can be programmed for different functions like Remote / Local, User / Macro Selection & JOG

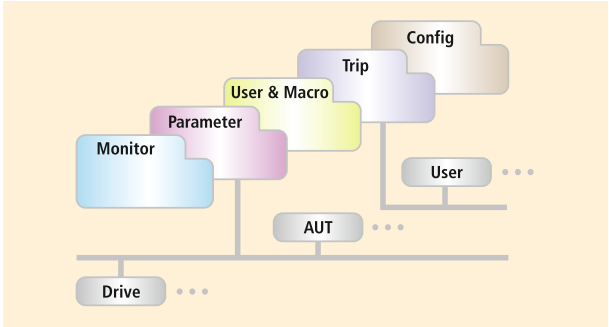
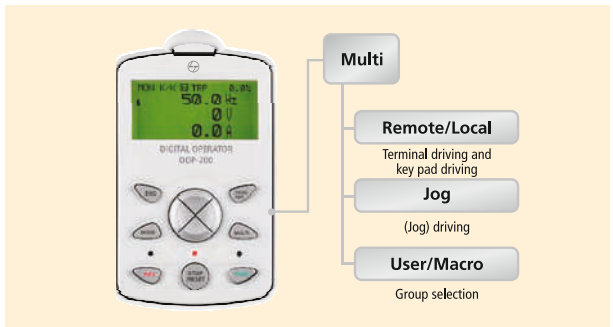

➤ **Efficient architecture of 5-mode 15-parameter groups**

Each mode has its own function items suitable for desired properties

eg. Monitor: Displays information on the operating status of the inverter

➤ **User & Macro group support**

- User can define parameters together they use often in User Macro
- Maximum 64 number of parameters can be saved
- Same parameter can be saved several times

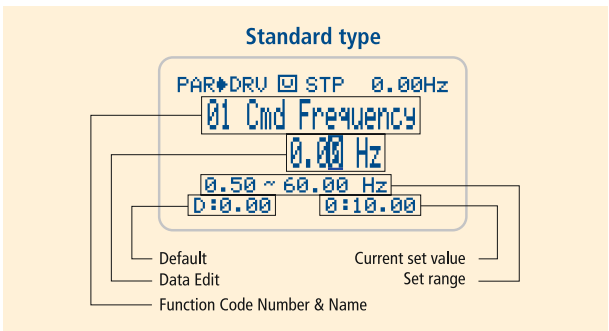
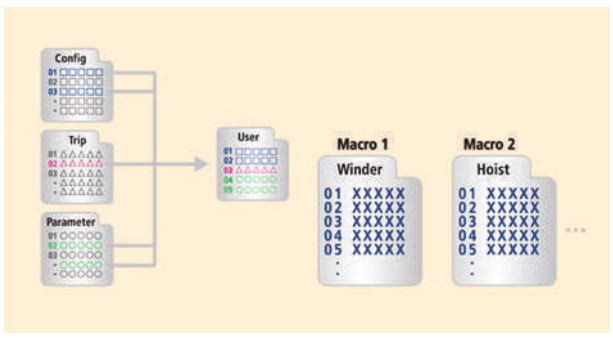

➤ **Wide viewing-angle graphic LCD keypad**

- 3 LED
- 11 Keys
- 4 Lines for monitoring
- Built-in memory to store parameters on keypad



› Built-in Crane Algorithm

Enhance-Torque Control

- 250% starting torque in closed loop control
- Overload capacity of 200% for 3 seconds

Built-in Brake Control

- Brake opening command by drive under the following conditions:
 - Inverter Output Frequency > Brake Release Frequency
 - Inverter Output Current > Brake Release Current
- Brake release with delay
- Ensures Slip prevention
- Brake Close frequency different settings possible for Hoisting & Lowering Motion

› Position Control Option

- Suitable for applications like cut to length
- Pulse train reference upto 200khz
- No need of external controller
- Reduces cycle time
- Reduces wastage of material

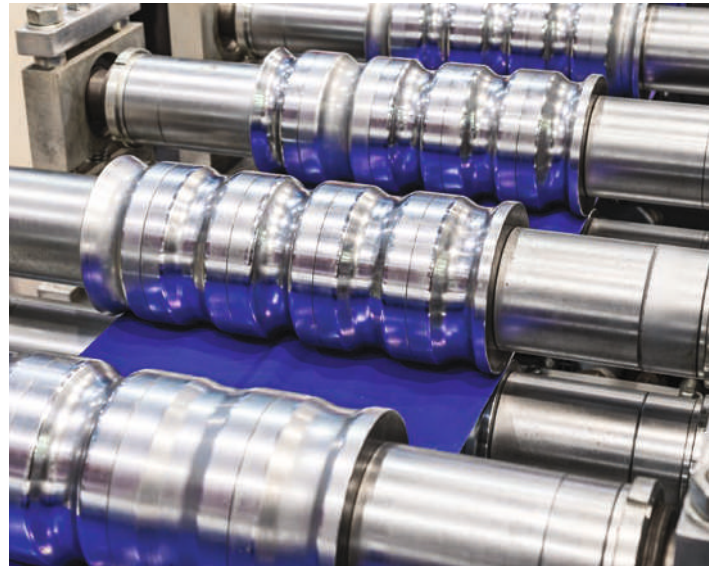

› Synchronisation Control

- Suitable for applications like roving frame, ring frame
- Maximum frequency upto 100kHz
- Position/Speed synchronization possible

Rated Input and Output: Input Voltage Three-Phase 415V (0.75 to 22kW - HD)

Type : LTVF-F4□□□□ □AA		0004	0006	0008	0012	0016	0024	0030	0039	0045	0061	
1) Applicable Motor (kW)	HD	0.75	1.5	2.2	3.7	5.5	7.5	11	15	18.5	22	
	ND	1.5	2.2	3.7	5.5	7.5	11	15	18.5	22	30	
Rated Output	2) Rated Capacity [A]	HD	2.5	4	6	8	12	16	24	30	39	45
		ND	4	6	8	12	16	24	30	39	45	61
	Rated Capacity [kVA]-HD		1.9	3	4.5	6.1	9.1	12.2	18.3	22.9	29.7	34.3
	Output Frequency		3) 0 ~ 400 [Hz] (Sensorless-1: 0~300Hz, Sensorless-2, Vector: 0.1~120Hz)									
Output Voltage [V]		4) 3-phase 380 ~ 480V										
Rated Input	Available Voltage [V]		3-phase 380 ~ 480 VAC (-15%, +10%)									
	Input Frequency		50 ~ 60 [Hz] (±5%)									
	Rated Current [A]	HD	2.2	3.6	5.5	7.5	11	14.4	22	26.6	35.6	41.6
ND		3.7	5.7	7.7	11.1	14.7	21.9	26.4	35.5	41.1	55.7	
DC Reactor		External [option]										Built-in
Braking Unit		Built-in										

Rated Input and Output: Input Voltage Three-Phase 415V (30 to 375kW - HD)

Type : LTVF-F4□□□□ □AA		0075	0091	0110	0152	0183	0223	0264	0325	0370	0432	0547	0613	0731	0877	
1) Applicable Motor (kW)	HD	30	37	45	55	75	90	110	132	160	185	220	280	315	375	
	ND	37	45	55	75	90	110	132	160	185	220	280	315	375	450	
Rated Output	Rated Capacity [kVA]-HD		46	57	69	84	116	139	170	201	248	286	329	416	467	557
	2) Rated Capacity [A]	HD	61	75	91	110	152	183	223	264	325	370	432	547	613	731
		ND	75	91	110	152	183	223	264	325	370	432	547	613	731	877
	Output Frequency		3) 0 ~ 400 [Hz] (Sensorless-1: 0~300Hz, Sensorless-2, Vector: 0.1~120Hz)													
Output Voltage [V]		4) 3-phase 380 ~ 480V														
Rated Input	Available Voltage [V]		3-phase 380 ~ 480 VAC (-15%, +10%)													
	Input Frequency		50 ~ 60 [Hz] (±5%)													
	Rated Current [A]	HD	55.5	67.9	82.4	102.6	143.4	174.7	213.5	255.6	316.3	404	466	605	674	798
ND		67.5	81.7	101.8	143.6	173.4	212.9	254.2	315.3	359.3	463	590	673	796	948	
DC Reactor		Built-in										External [option]				
Braking Unit		External [option]														

1) Motor Applied indicates the maximum capacity applied to use of a standard 4 pole standard motor.

2) The output of rated current is limited according to setting of the carrier frequency (CON-04).

3) In case of Sensorless-1, you can set the frequency at up to 300Hz by selecting 3, 4 as the control mode (DRV-09 Control Mode).

In case of Sensorless-2, you can set the frequency at up to 120Hz by selecting 3, 4 as the control mode (DRV-09 Control Mode).

4) The maximum output voltage does not go up over the supplied power voltage. You can select the output voltage as you want below the supplied power voltage.

	Range	Three-Phase 415V, 0.75 to 375kW (HD)
Standard Specifications	Enclosure Type	IP21 below 75kW (HD) & IP00 above 90kW till 375kW (HD)
	Overload Capacity	HD: 150%/ 1min; ND: 110%/ 1min, 200% instantaneous for 3 seconds
	Max Output Voltage	Proportional to input voltage
	Max Output Frequency	0 to 400Hz (1000Hz optional) (Sensorless-1: 0 to 300Hz, Sensorless-2, Vector: 0.0~120Hz)
	Rated Voltage	380 to 480V Three-phase (-15%/+10%)
	Rated Frequency	50/60Hz (-5%/+5%)
	Keypad	LCD Detachable
	DC Reactor	Built-in from 22kW (HD) to 280kW (ND)
	Braking Chopper	Built-in till 22kW (HD)
Control Details	Control Method	V/F, V/F with PG, Closed Loop Vector Control, Sensorless Vector Control, Slip Compensation
	Starting Torque	150% for 60 Sec, 200% / 0.3Hz (Sensorless), 250% / 0RPM (Vector)
	Frequency Control Range	0 to 400Hz in V/F, 0 to 300Hz in Sensorless 1, 0 to 120Hz in Sensorless 2 / Vector
	Frequency Precision Setting	Digital command operation : 0.01% of the maximum frequency Analog command operation : 0.1% of the maximum frequency
	Frequency Setting	Analog: 0 ~ 10[V], -10 ~ 10[V], 0 ~ 20[mA] Digital: keypad
	Output Frequency Resolution	0.01Hz
	V/F pattern	Linear, double reduction, user V/F
	Accel/Decel Time	0.0 to 6000 Sec
	Braking Torque	Continuous Regeneration Torque 20% (150% with DBR)
	Features	PID control, up-down, 2nd motor operation, 3-wire operation, DC brake, frequency limit, frequency jump, second source function, slip compensation, reverse rotation prevention, auto restarting, auto tuning flying start, energy buffering, power braking, flux braking, leakage current reduction, MMC, easy start
Protection	Faults	Over voltage, low voltage, over current, earth current detection, inverter overheat, motor overheating, output imaging, overload protection, communication error, frequency command loss, hardware failure, cooling fan failure, pre-PID failure, no motor trip, external brake trip
	Alarm	Stall prevention, overload, light load, encoder error, fan failure, keypad command loss, speed command loss
	Momentary Power Loss Ride Through	Continuous Operation: Heavy Loads below 15 msec & normal loads below 8msec Auto Restarts: Heavy Loads above 15 msec & normal loads above 8msec
Interface	DI	8 (Programmable NPN/PNP)
	DO	2 Programmable (1 NO/NC & 1 NO) + 1 TR
	AI	1Nos, 4-20mA & 1Nos, 0 to 10Vdc
	AO	1Nos, 4-20mA & 1Nos, 0 to 10Vdc
	Communication	Built-in RS485 Modbus RTU
Environment	Area of Use	Indoors, There shall not be corrosive air, combustible gas, oil mist, dust and other pollutants
	Ambient Temperature	-10°C to 50°C for HD, -10°C to 40°C for ND
	Storage Temperature	-20°C to 65°C
	PCB Protection	Conformal Coating complying to IEC 60721-3-3 class 3C2 (max) and class 3C3 (avg)
	Application Humidity	Upto 95% of relative humidity (with no dew formation)
	Altitude	Below 1000m
	Vibration	5.9m/sec ² (0.6G)
Global Compliance	CE, UL, RoHS	

➤ **PLC Card (LTAD-PLC-F)**

- Normal input 6 points (Sink/Source selectable), Max. input 14 points when expanded
- Normal output 4 points (N.O. Relay), Max. output 7 points when expanded
- RTC (Real Time Clock)

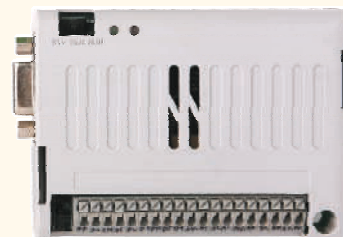

➤ **Encoder Card (LTEN-INC-F)**

- Closed loop control
- Pulse train reference
- Line driver or open collector type of encoders
- 200kHz max. input frequency
- Signal loss detection
- 5/12/15 V insulated power supply



➤ **Profibus-DP Card (LTCI-PDP-F)**

- Profibus dedicated connector
- Max. 12Mbps communication speed
- Max. 32 stations per segment
- Bus topology
- Enhanced on-line diagnosis



➤ **I/O Expansion Card 1 (LTIO-EX1-F)**

- Digital input - 3 (PNP / NPN)
- Digital output - 3 (NO) AC 250V - 5A / DC 30V - 5A
- Analog input - 2, 1 Voltage (-10 to +10V)
 1 Current (0 to 20mA)
- Analog output - 2, 1 Voltage (-10 to +10V)
 1 Current (0 to 20mA)



➤ **I/O Expansion Card 2 (LTIO-EX2-F)**

- Digital output - 2 (TR) Max 26V, 100mA
- Analog input - 4, Voltage (-10 to +10V) /
 Current (0 to 20mA)
- Analog output - 4, 2 Voltage (-10 to +10V)
 2 Current (0 to 20mA)



› Ethernet Card (LTCI-ETH-F)

- Modbus TCP, Ethernet IP Protocol support
- 10Mbps, 100Mbps communication speed
- Half duplex, full duplex support
- Auto negotiation
- Max. 100m(328 ft.) transmission distance
- CSMA/CD communication access method
- Analog voltage (-10~10V) I/O 2 points
- Analog current (0~20mA) I/O 2 points



› DeviceNet (LTCI-DEN-F)

- Communication speed: 125kbps, 250kbps, 500kbps
- Tree/Bus topology
- Max. 64 node connection points
- Max. 500m (1640 ft.) transmission distance (125kbps)



› CANopen Card (LTCI-CAN-F)

- 1Mbps communication speed
- Bus Topology
- Max. 64 node connection points (include master)



› Synchronization Option Card (LTCN-SYN-F)

- Closed-loop control
- 100kHz max. input frequency
- For parallel connection 15 slaves per master (5 parallel max)
- For serial connection 5 slaves per master
- Position/Speed synchronization
- Synchronization hold (only slave)
- Open collector output: 26V/100mA (2 points)



› Position Control Option Card (LTCN-PCN-F)

- Closed-loop control
- Pulse train reference
- Line driver or open collector type of encoders
- 200kHz max. input frequency
- Signal loss detection
- External brake control
- 5/12/15V insulated power supply

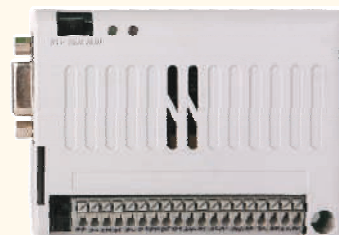

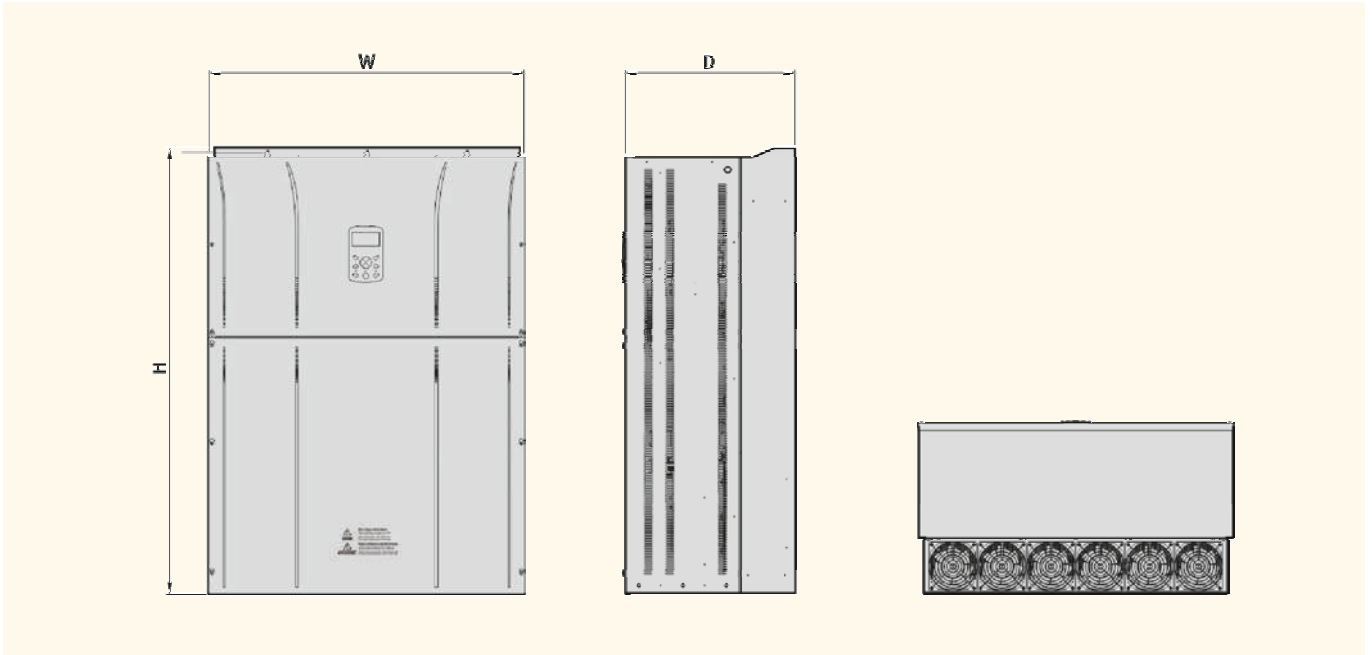

Drive Cat No	W (mm)	H (mm)	D (mm)	Weight (kg)
LTVF-F40004CAA	150.0	284.0	200.0	4.8
LTVF-F40006CAA	150.0	284.0	200.0	4.8
LTVF-F40008CAA	150.0	284.0	200.0	4.8
LTVF-F40012CAA	150.0	284.0	200.0	4.8
LTVF-F40016CAA	200.0	355.0	225.0	8.0
LTVF-F40024CAA	200.0	355.0	225.0	8.0
LTVF-F40030CAA	250.0	385.0	284.0	14.3
LTVF-F40039CAA	250.0	385.0	284.0	14.3
LTVF-F40045CAA	280.0	461.0	298.0	20.0
LTVF-F40061CAA	280.0	461.0	298.0	30.3
LTVF-F40075CAA	300.1	594.1	303.2	41.3
LTVF-F40091CAA	300.1	594.1	303.2	41.3
LTVF-F40110CAA	300.1	594.1	303.2	41.3
LTVF-F40152CAA	370.1	663.5	373.3	63.3
LTVF-F40183CAA	370.1	663.5	373.3	63.3
LTVF-F40223AAA	510.0	783.5	422.6	101.3
LTVF-F40264AAA	510.0	783.5	422.6	101.0
LTVF-F40325AAA	510.0	861.0	422.6	114.0
LTVF-F40370AAA	510.0	861.0	422.6	114.0
LTVF-F40432AAA	690.0	1,078.0	450.0	200.0
LTVF-F40547AAA	690.0	1,078.0	450.0	200.0
LTVF-F40613AAA	771.0	1,138.0	440.0	252.0
LTVF-F40731AAA	922.0	1,302.5	495.0	352.0
LTVF-F40877AAA	922.0	1,302.5	495.0	352.0

Note: The above drawings are solely for reference purposes. Please refer to the technical manual.

Sx2000



The Sx2000 adds a new dimension to E&A's AC drive solutions. Built to E&A's stringent quality standards, the Sx2000 is tested and certified to meet global benchmarks, giving you the assurance of total reliability. The Sx2000 is built to deliver powerful performance. It produces a starting torque of 200% at 0.5 Hz, which provides better control at low-speed. Its compact size enables panel-size reduction, hence helps in space-efficient design.



› Main Features

- Range: 0.75kW to 90kW
- V/F, Sensorless Vector Control, Slip Compensation
- Starting Torque of 200% at 0.5Hz for Sensorless Control
- Component Life Monitor
- Peer to Peer Communication to share I/Os
- Built-in PLC Logic
- Built-in Brake Control
- Multi Keypad
- Stores last 5 faults
- Conformal Coating complying to IEC 60721-3-3 class 3C2 (max) and class 3C3 (avg)
- Built-in RS485 Modbus RTU Communication

› Applications

- OEM Machines
- Elevators
- Plastic & Textile Machines
- Conveyors
- Compressors
- Wire Drawing
- Extruders
- AHU Control
- Fan & Pump
- Crane Hoist
- Crane Control LT / CT
- Solar Pump

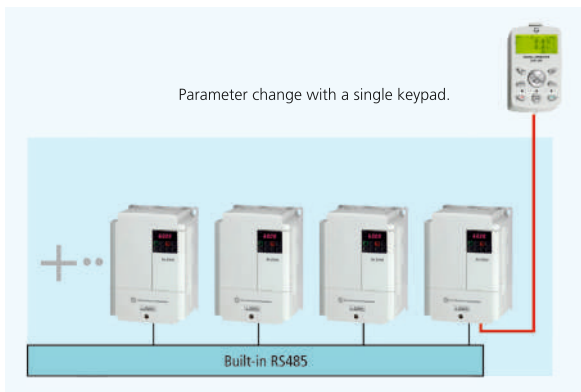

Multi-keypad function

Single LCD keypad can be used to set up the parameters of RS485 connected drives.

- LCD (LTOP-DOP-200) keypad (same as Fx2000 model) enables handy parameter set-up.
- Multi-language support available

User sequence function (PLC Logic)

- Simple PLC sequences can be operated with various function block combinations with direct access to Drive parameters.
- Function blocks: AND, NOR, ADD, SUB, XOR, MIN, MAX, COMPARE, TIMER, SWITCH, UP/DWN COUNT..etc
- No Software required to create logic

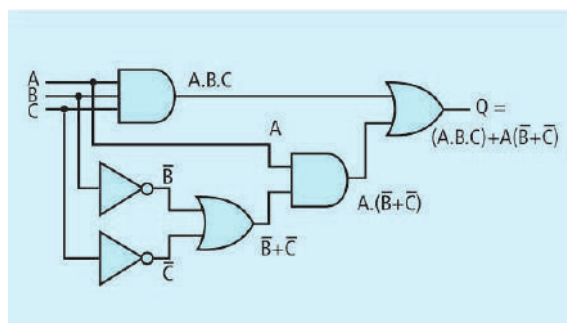

Peer-to-Peer function embedded

I/O's can be shared among master and slave drives. (RS485 wiring required).

Built-in Brake Control

- Brake opening command by drive under the following conditions:
 - Inverter Output Frequency > Brake Release Frequency
 - Inverter Output Current > Brake Release Current
- Brake release with delay
- Ensures Slip prevention
- Brake Close frequency different settings possible for Hoisting & Lowering Motion

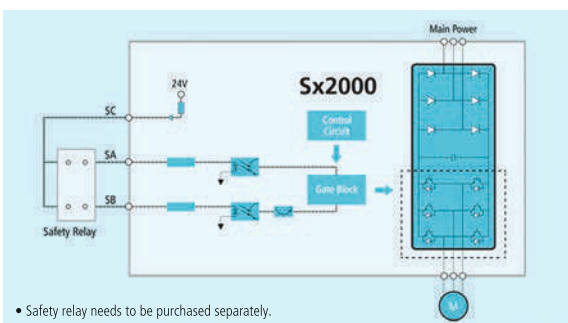

Safety Function

Sx2000 has in-built safety functions conforming to modern safety standards.

The safety input function meets EN ISO 13849-1 PLd and EN 61508 SIL2 (EN60204-1, stop category 0). This feature is standard and enables compliance with current safety standards.

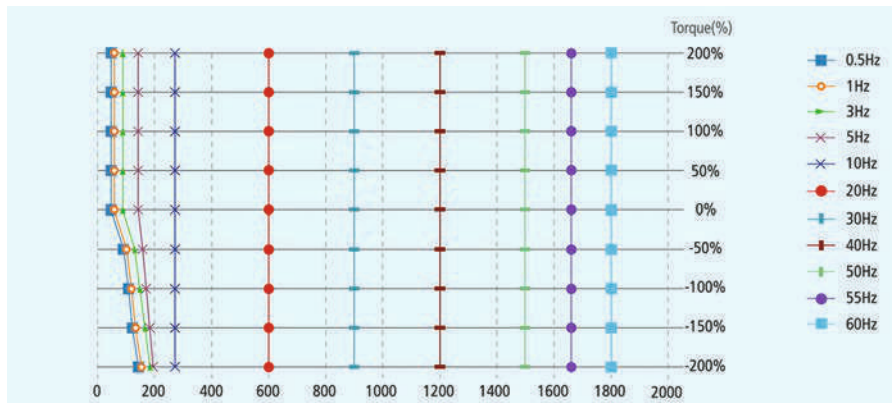

Powerful sensorless control

Starting torque of 200%/0.5Hz is produced and provides robust power in the low speed region. The motor auto-tuning function is optimised to maximise motor performance.

Flying-start function

Drive capable of reliable and smooth re-starts even for bi-directional rotating loads.

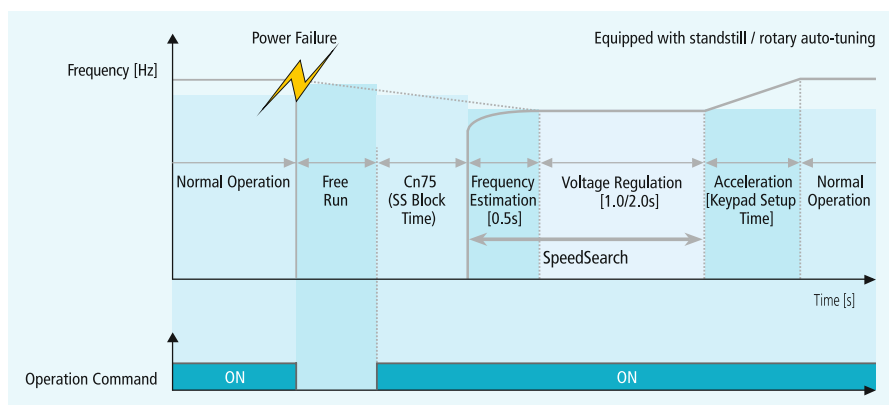

Main capacitor lifecycle estimation

Estimated through monitoring the change in the capacitance value.

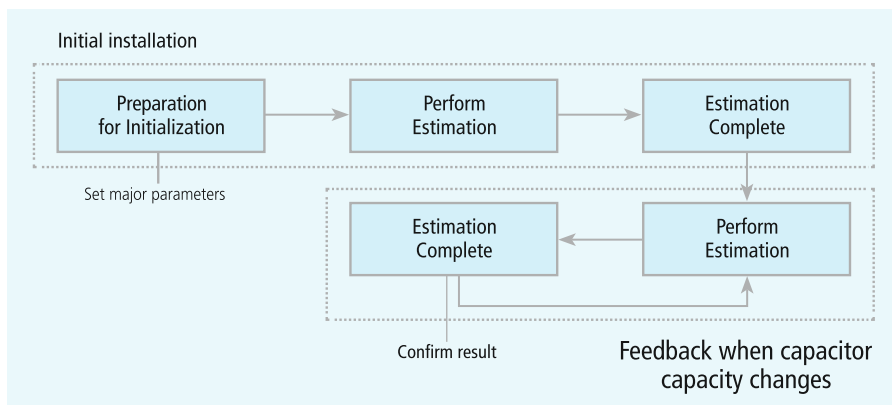

Fan lifecycle estimation

Warning signal is displayed when fan is operated over a certain amount of hours.

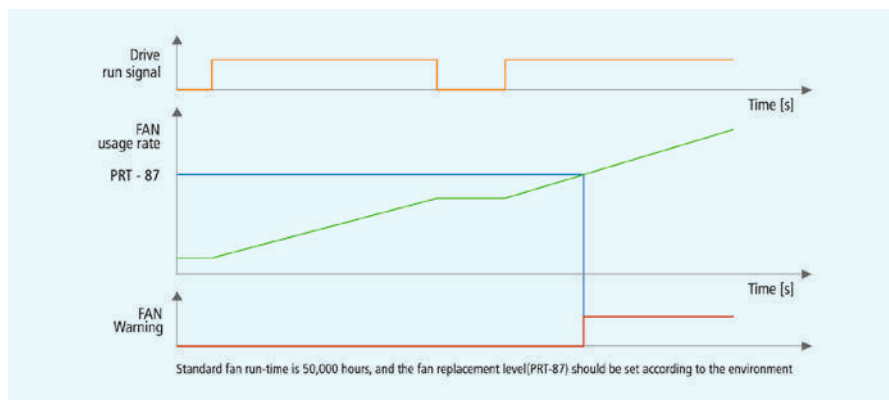

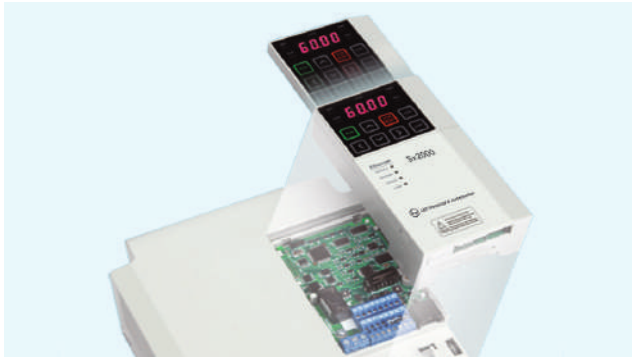

Optional Accessories - easy to install & use

- *Optional fieldbus networks:
- ① Profibus-DP (LTCI-PDP-S.)
 - ② Modbus TCP / Ethernet IP (LTCI-ETH-S.)
 - ③ CANopen (LTCI-CAN-S)

*I/O Expansion Card (LTIO-EXP-S.):

- Digital input - 3 (PNP / NPN)
- Digital output - 2 (R) AC 250V - 1A / DC 30V - 1A
- Analog input - 2, 1 Voltage (-10 to +10V)
1 Current (0 to 20mA) / 1 Voltage (0 to +10V)
- Analog output - 1, 1 Voltage (0 to +10V) / 1 Current (0 to 20mA)

*Only one option card can be used at a time.

Simple cooling fan replacement

Tool-less replacement of cooling fan without dismantling the drive

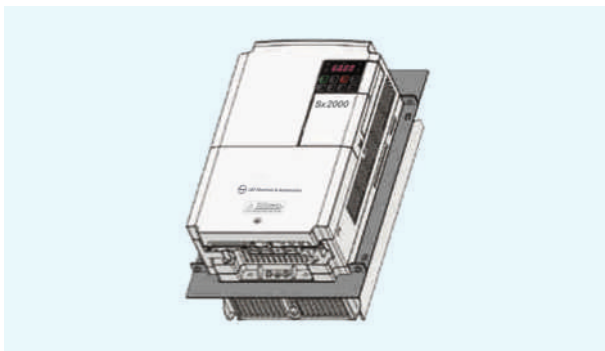
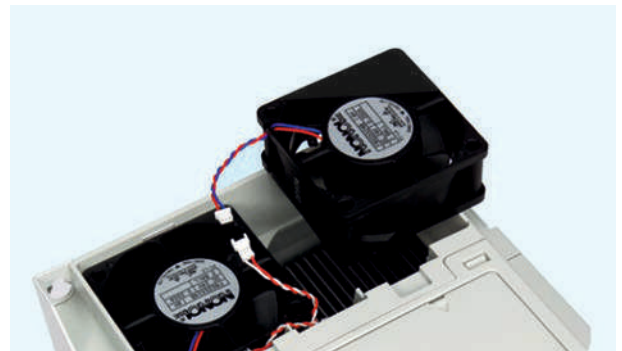

Flange type

To reduce heat losses inside the panel
The heat sink can be mounted outside of the panel in case the space is limited.

*Please contact L&T representative for details.

Built-in DC reactor

Effective in improving power factor and decreasing THD.

- 3-phase 400V 37~90kW (ND)

Dual rating operation

Designed to be used for heavy and normal duty applications.

Overload capacity:

- Heavy duty operation **150%** of rated current, 60 seconds
- Normal duty operation **120%** of rated current, 60 seconds

DriveConnect software allows drive/system monitoring on a PC and easy maintenance of drive and motor parameters

- Windows-based graphic user interface (GUI)
- Modbus-RTU
- Connecting up to 31 drives
- Integrated control console
- Offline editing function
- Data upload/download
- 4-channel oscilloscope
- Trigger function

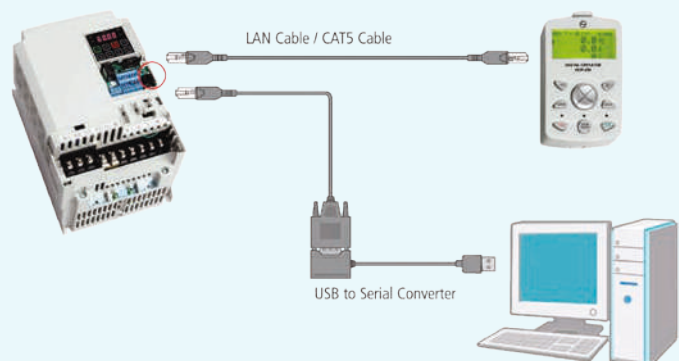

➤ Input and output specification: **Input Voltage Single-Phase 230V (0.75 to 3.7kW - ND)**

LTVF-S1 □□□□ BAA			0003	0006	0010	0012	
Applicable Motor	Heavy Duty [HD]	HP	0.5	1.0	2.0	3.0	
		kW	0.4	0.75	1.5	2.2	
	Normal Duty [ND]	HP	1.0	2.0	3.0	5.0	
		kW	0.75	1.5	2.2	3.7	
Output Rating	Capacity [kVA]	Heavy Duty [HD]	1.0	1.9	3.0	4.2	
		Normal Duty [ND]	1.2	2.3	3.8	4.6	
	Rated Current [A]	Heavy Duty [HD]	2.5	5.0	8.0	11.0	
		Normal Duty [ND]	3.1	6.0	9.6	12.0	
	Frequency [Hz]		0~400Hz (IM Sensorless : 0~120[Hz])				
Voltage [V]		3-phase 200~240V					
Input Rating	Voltage [V]		1-phase 200~240VAC (-15% ~ +10%)				
	Frequency [Hz]		50~60Hz (±5%)				
	Rated Current [A]	Heavy Duty [HD]	4.8	9.3	15.6	21.7	
Normal Duty [ND]		5.8	11.7	19.7	24.0		
Display		LED [LCD optional]					
Braking Unit		Built-in					

➤ Input and output specification: **Input Voltage Three-Phase 230V (0.75 to 18.5kW - ND)**

LTVF-S2 □□□□ BAA			0003	0006	0010	0012	0018	0030	0040	0056	0069	
Applicable Motor	Heavy Duty [HD]	HP	0.5	1.0	2.0	3.0	5.4	7.5	10.0	15.0	20.0	
		kW	0.4	0.75	1.5	2.2	4.0	5.5	7.5	11.0	15.0	
	Normal Duty [ND]	HP	1.0	2.0	3.0	5.0	7.5	10.0	15.0	20.0	25.0	
		kW	0.75	1.5	2.2	3.7	5.5	7.5	11.0	15.0	18.5	
Output Rating	Capacity [kVA]	Heavy Duty [HD]	1.0	1.9	3.0	4.2	6.5	9.1	12.2	17.5	22.9	
		Normal Duty [ND]	1.2	2.3	3.8	4.6	6.9	11.4	15.2	21.3	26.3	
	Rated Current [A]	Heavy Duty [HD]	2.5	5.0	8.0	11.0	17.0	24.0	32.0	46.0	60.0	
		Normal Duty [ND]	3.1	6.0	9.6	12.0	18.0	30.0	40.0	56.0	69.0	
	Frequency [Hz]		0~400Hz (IM Sensorless : 0~120[Hz])									
Voltage [V]		3-phase 200~240V										
Input Rating	Voltage [V]		3-phase 200~240VAC (-15% ~ +10%)									
	Frequency [Hz]		50~60Hz (±5%)									
	Rated Current [A]	Heavy Duty [HD]	2.2	4.9	8.4	11.8	18.5	25.8	34.9	50.8	66.7	
Normal Duty [ND]		3.0	6.3	10.8	13.1	19.4	32.7	44.2	62.3	77.2		
Display		LED [LCD optional]										
Braking Unit		Built-in										

➤ Input and output specification: **Input Voltage Three-Phase 415V (0.75 to 30kW - ND)**

LTVF-S4 □□□□ BAA			0002	0003	0005	0007	0010	0016	0023	0030	0038	0044	0058	
Applicable Motor	Heavy Duty [HD]	HP	0.5	1.0	2.0	3.0	5.4	7.5	10.0	15.0	20.0	25.0	30.0	
		kW	0.4	0.75	1.5	2.2	4.0	5.5	7.5	11.0	15.0	18.5	22.0	
	Normal Duty [ND]	HP	1.0	2.0	3.0	5.0	7.5	10.0	15.0	20.0	25.0	30.0	40.0	
		kW	0.75	1.5	2.2	3.7	5.5	7.5	11.0	15.0	18.5	22.0	30.0	
Output Rating	Capacity [kVA]	Heavy Duty [HD]	1.0	1.9	3.0	4.2	6.5	9.1	12.2	18.3	22.9	29.7	34.3	
		Normal Duty [ND]	1.5	2.4	3.9	5.3	7.6	12.2	17.5	22.9	29.0	33.5	44.2	
	Rated Current [A]	Heavy Duty [HD]	1.3	2.5	4.0	5.5	9.0	12.0	16.0	24.0	30.0	39.0	45.0	
		Normal Duty [ND]	2.0	3.1	5.1	6.9	10.0	16.0	23.0	30.0	38.0	44.0	58.0	
	Frequency [Hz]		0~400Hz (IM Sensorless : 0~120[Hz])											
	Voltage [V]		3-phase 380~480V											
Input Rating	Voltage [V]		3-phase 380~480VAC (-15% ~ +10%)											
	Frequency [Hz]		50~60Hz (±5%)											
	Rated Current [A]	Heavy Duty [HD]	1.1	2.4	4.2	5.9	9.8	12.9	17.5	26.5	33.4	43.6	50.7	
		Normal Duty [ND]	2.0	3.3	5.5	7.5	10.8	17.5	25.4	33.4	42.5	49.5	65.7	
DC Reactor		External [option]												
Display		LED [LCD optional]												
Braking Unit		Built-in												

➤ Input and output specification: **Input Voltage Three-Phase 415V (37 to 90kW - ND)**

LTVF-S4 □□□□ BAA			0075	0091	0107	0142	0169
Applicable Motor	Heavy Duty [HD]	HP	40.0	50.0	60.0	75.0	100.0
		kW	30.0	37.0	45.0	55.0	75.0
	Normal Duty [ND]	HP	50.0	60.0	75.0	100.0	120.0
		kW	37.0	45.0	55.0	75.0	90.0
Output Rating	Capacity [kVA]	Heavy Duty [HD]	46.5	57.2	69.4	83.8	115.8
		Normal Duty [ND]	57.2	69.4	81.5	108.2	128.8
	Rated Current [A]	Heavy Duty [HD]	61.0	75.0	91.0	110.0	152.0
		Normal Duty [ND]	75.0	91.0	107.0	142.0	169.0
	Frequency [Hz]		0~400Hz (IM Sensorless : 0~120[Hz])				
	Voltage [V]		3-phase 380~480V				
Input Rating	Voltage [V]		3-phase 380~480VAC (-15% ~ +10%)				
	Frequency [Hz]		50~60Hz (±5%)				
	Rated Current [A]	Heavy Duty [HD]	56.0	69.0	85.0	103.0	143.0
		Normal Duty [ND]	69.0	85.0	100.0	134.0	160.0
DC Reactor		Built-in					
Display		LCD					
Braking Unit		External [option]					

	Range	Single-Phase 230V	Three-Phase 230V	Three-Phase 415V
		0.75 to 3.7kW (ND)	0.75 to 18.5kW (ND)	0.75 to 90kW (ND)
Standard Specifications	Enclosure Type	IP20		
	Overload Capacity	HD: 150% for 1min, ND: 120% for 1min; 200% instantaneous for 1 second		
	Max Output Voltage	Proportional to Input Voltage		
	Max Output Frequency	0 to 400Hz (Sensorless: 0 to 120Hz)		
	Rated Voltage	380 to 480V Three-phase (-15%/+10%)		
	Rated Frequency	50/60Hz (-5%/+5%)		
	Keypad	Built-in LED till 30kW (ND) & Above 30kW standard Detachable LCD		
	Braking Chopper	Built-in up to 30kW (ND)		
	DC Reactor	Built-in from 37kW to 90kW		
Control Details	Control Method	V/F, Sensorless Vector Control, Slip Compensation		
	Starting Torque	200% at 0.5Hz for Sensorless Control & 150% at 3Hz for V/F		
	Frequency Control Range	0.01 to 400Hz for V/F , 0 to 120Hz for Sensorless Vector Control		
	Frequency Precision Setting	Digital command: 0.01Hz Analog command: 0.03Hz (Max. frequency: 60Hz)		
	Frequency Setting	Analog type: - 10 to 10V, +0 to 10[V], 4 to 20[mA], Digital type: Keypad, panel potentiometer, pulse train input		
	Output Frequency Resolution	0.01Hz		
	V/F pattern	Linear, squared, user V/F		
	Accel/Decel Time	0.0 to 6000 Sec		
	Braking Torque	Continuous Regeneration Torque 20% (150% with DBR)		
	Features	Multi keypad, peer-to-peer communication to share I/Os, user sequence, inbuilt PID, component life monitor, no motor detection, auto tuning, KEB, DI/DO ON-OFF delay, torque boost, DC braking, fire mode, flux braking, 2 nd motor, frequency jump slip compensation, External PIDs		
Protection	Faults	Under load trip, low voltage trip, phase loss trip, no motor trip, external brake trip, safety input error, IO board trip inverter overload warning, lost command warning, overheat Trip, encoder trip, DBR %ED warning		
	Alarm	Command Loss trip, overload, inverter overload, fan operation, resistance braking		
	Momentary Power Loss Ride Through	Continuous Operation: Heavy Loads less then 15msec, normal load less then 8msec, Auto Restart Operation: Heavy Loads more then 15msec, normal load more then 8msec		
Interface	DI	7 (Programmable NPN/PNP)		
	DO	1 (Programmable NO/NC) + 1 TR till 30kW, 2 (Programmable NO/NC) + 1 TR above 30kW		
	AI	1 (-10 + 10Vdc) & 1 (4-20mA / - 10 to + 10Vdc)		
	AO	1 (4-20mA / 0 to 10Vdc) till 30kW, 1 (4-20mA / 0-10Vdc) + 1 (0 to 10Vdc) above 30kW		
	Pulse Train	1 I/P & 1 O/P (0 to 32Khz)		
	Communication	Built-in RS485 Modbus RTU		
	Safety I/P	2, complying with EN ISO 13849-1 Pld and EN61508SIL2 [EN60204-1, stop category 0]		
Environment	Area of Use	Indoors. There shall not be corrosive air, combustible gas, oil mist, dust and other pollutants		
	Ambient Temperature	-10°C to 50°C for HD, -10°C to 40°C for ND		
	Storage Temperature	-20°C to 65°C		
	PCB Protection	Conformal Coating complying to IEC 60721-3-3 class 3C2 (max) and class 3C3 (avg)		
	Application Humidity	Upto 95% of relative humidity (with no dew formation)		
	Altitude	Below 1000m		
	Vibration	9.8m/sec ² (1G)		
Global Compliance	CE, UL (Plenum Rated), RoHS			

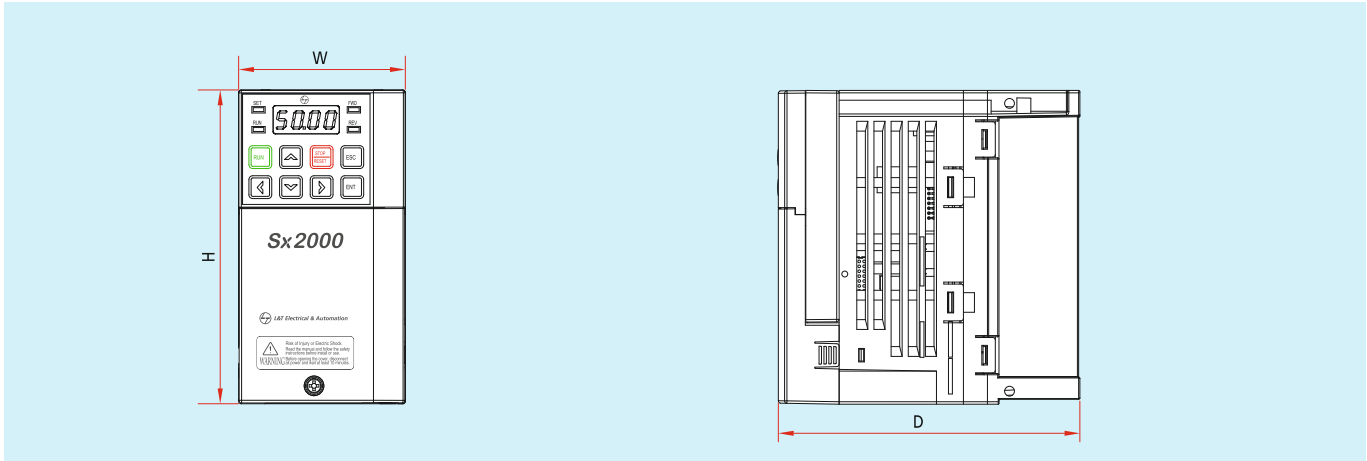

Input Voltage	Drive Cat. No.	W (mm)	H (mm)	D (mm)	Weight (kg)
Single-Phase 230 V	LTVF-S10003BAA	68	128	128	0.88
	LTVF-S20003BAA	68	128	123	0.86
Three-Phase 230 V	LTVF-S20006BAA	68	128	128	0.86
	LTVF-S40002BAA	68	128	123	0.86
Three-Phase 415 V	LTVF-S40003BAA	68	128	128	0.88

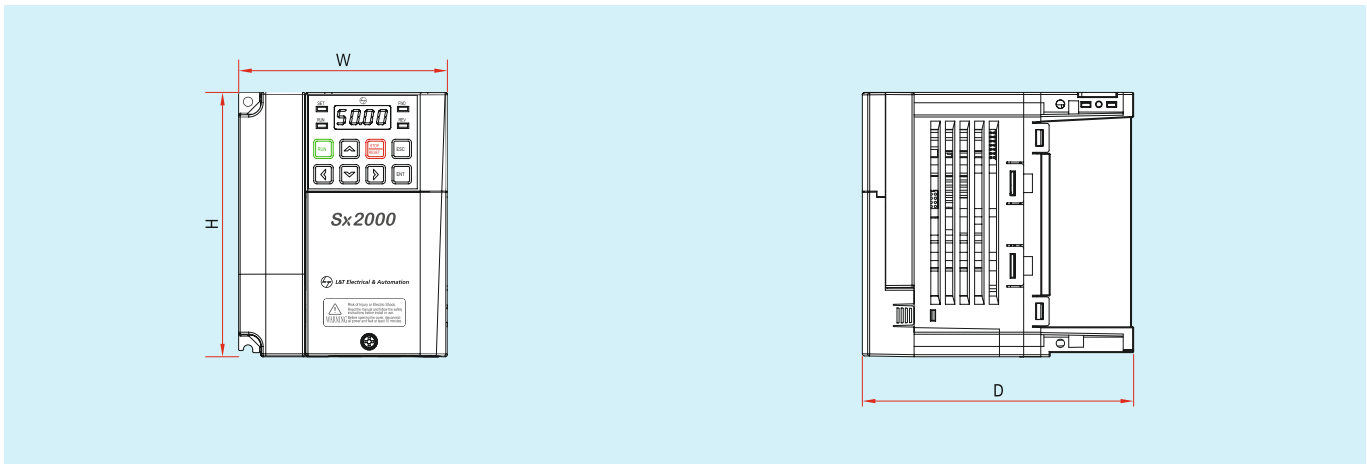

Input Voltage	Drive Cat. No.	W (mm)	H (mm)	D (mm)	Weight (kg)
Single-Phase 230 V	LTVF-S10006BAA	100	128	130	1.3
	LTVF-S10010BAA	100	128	145	1.5
	LTVF-S10012BAA	140	128	145	2.2
Three-Phase 230 V	LTVF-S20010BAA	100	128	130	1.5
	LTVF-S20012BAA	100	128	145	1.5
	LTVF-S20018BAA	140	128	145	2.3
Three-Phase 415 V	LTVF-S40005BAA	100	128	130	1.5
	LTVF-S40007BAA	100	128	145	1.5
	LTVF-S40010BAA	140	128	145	2.7

Note: The above drawings are solely for reference purposes. Please refer to the technical manual.

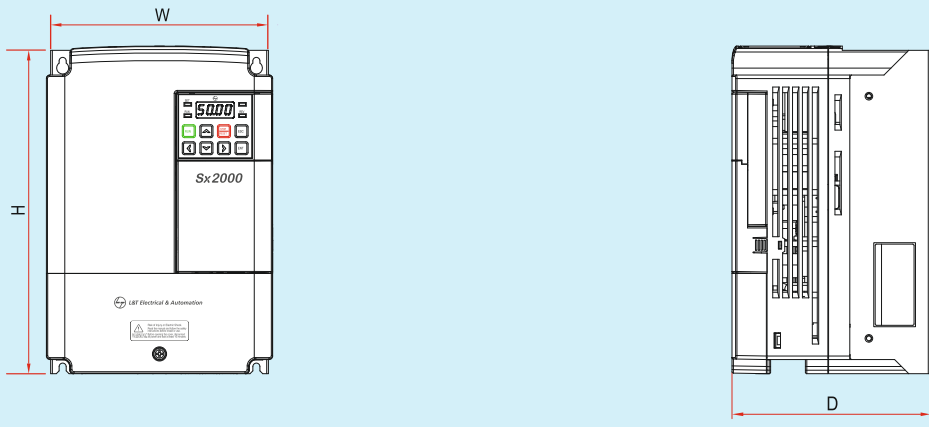

Input Voltage	Drive Cat. No.	W (mm)	H (mm)	D (mm)	Weight (kg)
Three-Phase 230 V	LTVF-S20030BAA	160	232	140	3.3
	LTVF-S20040BAA	160	232	140	3.3
	LTVF-S20056BAA	180	290	163	4.6
	LTVF-S20069BAA	220	350	187	4.6
Three-Phase 415 V	LTVF-S40016BAA	160	232	140	3.3
	LTVF-S40023BAA	160	232	140	3.4
	LTVF-S40030BAA	180	290	163	4.6
	LTVF-S40038BAA	180	290	163	4.8
	LTVF-S40044BAA	220	350	187	7.5
	LTVF-S40058BAA	220	350	187	7.5

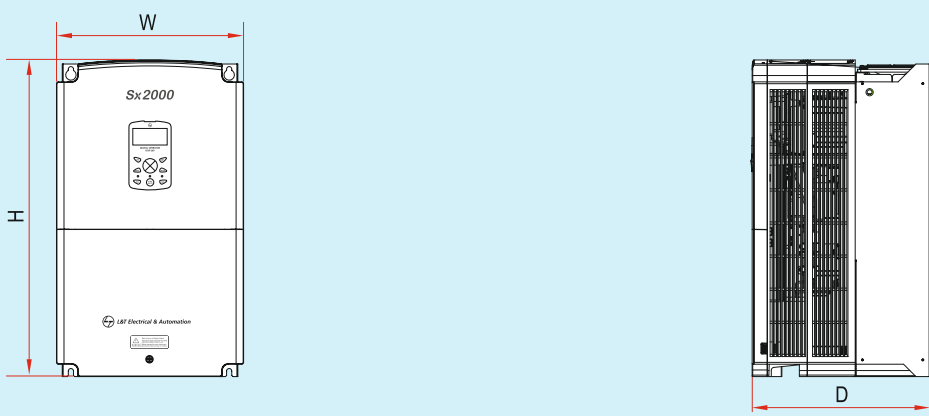

Input Voltage	Drive Cat. No.	W (mm)	H (mm)	D (mm)	Weight (kg)
Three-Phase 415 V	LTVF-S40075BAA	275	450	284	26
	LTVF-S40091BAA	325	510	284	35
	LTVF-S40107BAA	325	510	284	35
	LTVF-S40142BAA	325	550	309	43
	LTVF-S40169BAA	325	550	309	43

Note: The above drawings are solely for reference purposes. Please refer to the technical manual.

Hx2000



The Hx2000 adds a new dimension to E&A's AC drive solutions. It sets the standard for the industry by introducing an innovative energy reduction, environmental-friendly system that delivers outstanding energy savings for fan, pump and compressor applications in an HVAC system.

Built to E&A's stringent quality standards, the Hx2000 is tested and certified to meet global benchmarks, thus giving you the assurance of total reliability. It handles loads from 0.75kW to 90kW, and is engineered to keep your process operating at optimum efficiency, even in the hot, humid and dusty conditions that characterise India's industrial environment.



› Main Features

- V/F, Slip Compensation
- Built-in RTC for Scheduling
- Password Protection
- Built-in EMC filter class C3
- Optional EMC filter class C1/C2
- Built-in DC reactor
- Fire Mode
- Multi-Motor Control
- Built-in Payback Counter
- Lubrication Control
- Pump Clean Function
- Dry Pump Detection
- Built-in 4 PID
- Flow Compensation
- Built-in RS-485 Communication - BACnet, Modbus-RTU, Metasys N2
- Global Specifications Compliant- CE, UL (Plenum Rated)
- Conformal Coating complying to IEC 60721-3-3 class 3C2 (max) and class 3C3 (avg)

› Applications

- Compressor
- Supply Fan
- Exhaust Fan
- Cooling Tower
- Circulation Pump
- Vacuum Pump
- Positive Displacement Pumps

Multi Motor Control (MMC)

MMC is used when a single drive is used to control multiple motors in pump systems. It controls 1 main motor and 5 auxiliary motors as a default and upto 8 auxiliary motors with option card.

The main motor is connected to the drive output and is controlled by the built-in PID controller. Auxiliary motors are connected with the supply power and are turned ON/OFF by a relay within the drive.

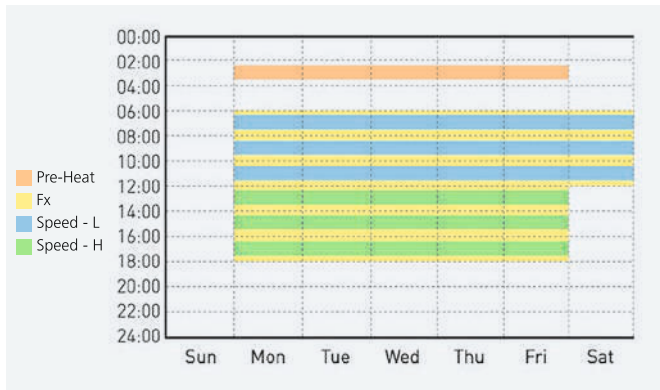
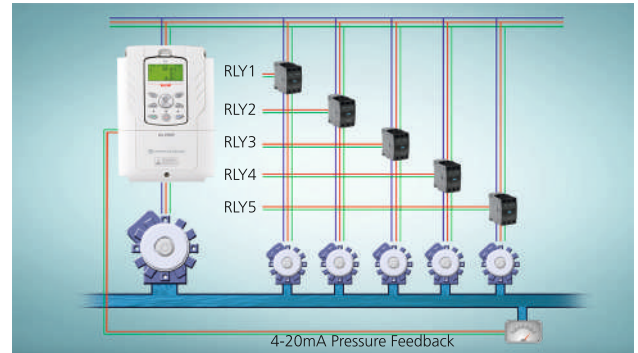

Time Event Scheduling: Real Time Clock (RTC)

RTC is used so that selected functions are operable during the set time. The user needs to configure the following:

- 4 Time Period Modules (Weekly)
- 8 Time Events
- 8 Exception Dates (Day)

(Possible to set 29 functions including FWD (Fx), REV (Rx), multiple acceleration/deceleration times, multiple frequencies, PID related functions and pre-heat)
Summer time available (Start/End date setting)

4 Process PIDs (1 Main + 3 EPIDs)

Main PID uses inputs from sensors to measure variables like pressure, temperature/humidity and flow, to change the motor speed by varying the output frequency to achieve the desired process output.

Three external PIDs control the external equipments of the HVAC system such as dampers, valves based on the feedback from CO₂, Rh, temperature, pressure & other sensors.

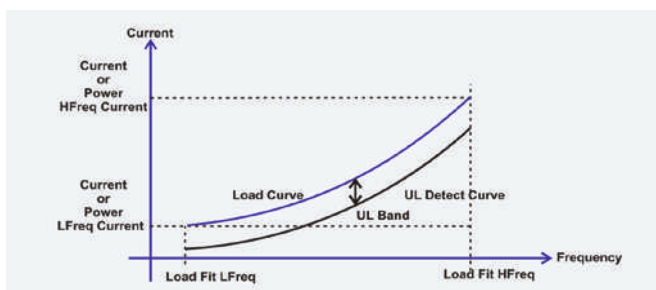
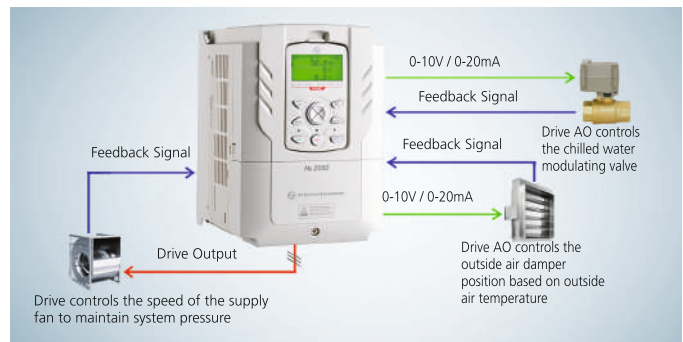

Dry Pump (Under Load Protection)

It prevents pump damage when there is insufficient water in the tank. If the actual load is below the Under Load (UL) Detect curve, the drive will trigger a warning or trip signal to protect the pump.



› Energy Saving

The energy saving information is displayed as kWh, saved energy cost and CO₂ emission level on the drive keypad.



› Keypad Exclusive for HVAC

Used to issue commands, configure drive parameters, and for monitoring drive status

- HAND Mode (Local Control Mode) or AUTO Mode (Remote Control Mode) can be selected
 - HAND Mode: Used when selecting frequency or run/stop commands
 - AUTO Mode: Drive operated using the keypad, multifunctional terminal block and communications
- Fault Status Monitoring

› Built-in EMC Filter

A built-in EMC filter meets the specifications for noise reduction

- 400V 0.75~90kW Built-in as default (Class C3) & optional (Class C1/C2)

› Built-in DC Reactor

A built-in DC Reactor effectively improves the power factor and reduces the THD

- Built-in as standard for 400V 37~90kW & optional AC/DC reactor upto 30kW

› Global Specifications Compliant

UL (Plenum Rated)

(American standards for conditioner fire safety)

- Suitable for installation in a compartment handling conditioned air



Soft Fill Operation

Prevents pump damage caused by excessive pressure building-up in the pipe system at the time of initial operation of pumps or inside the pumps.

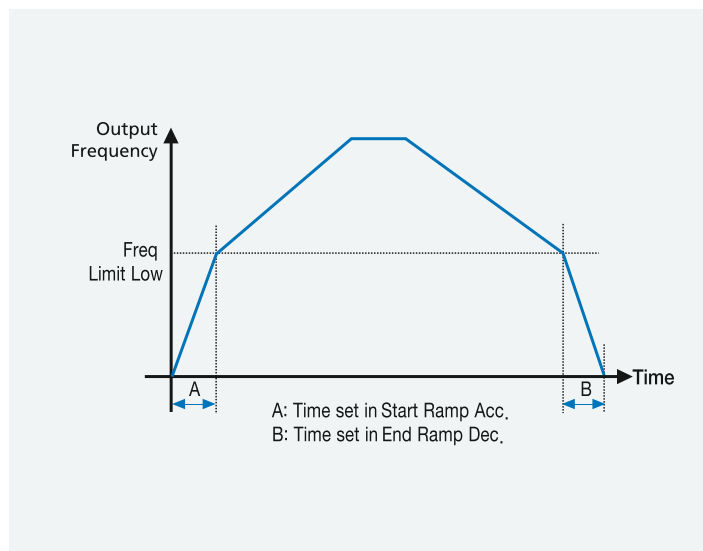
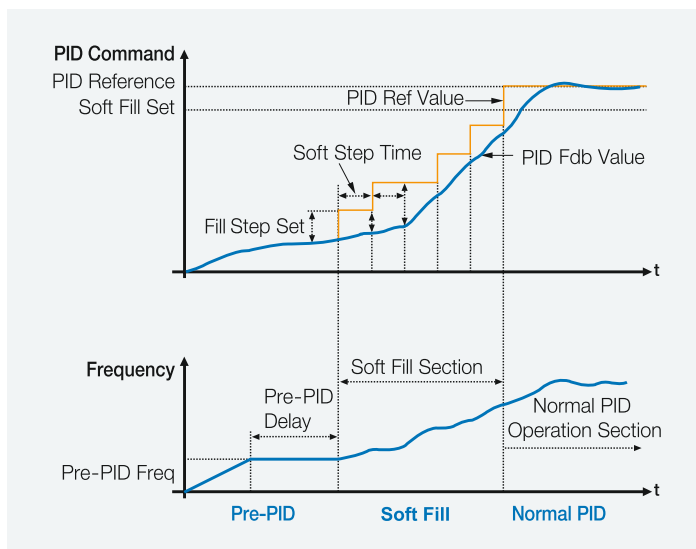

Start Ramp & End Ramp

Prevents pump damage by changing ramp using acceleration/deceleration time setting upon initial pump operation and stopping.

Deceleration Valve Ramp

Prevents pump and pipe damage caused by sudden pressure changes when pumps are stopped or a pump valve is closed, based on specific requirements, deceleration time can be set.

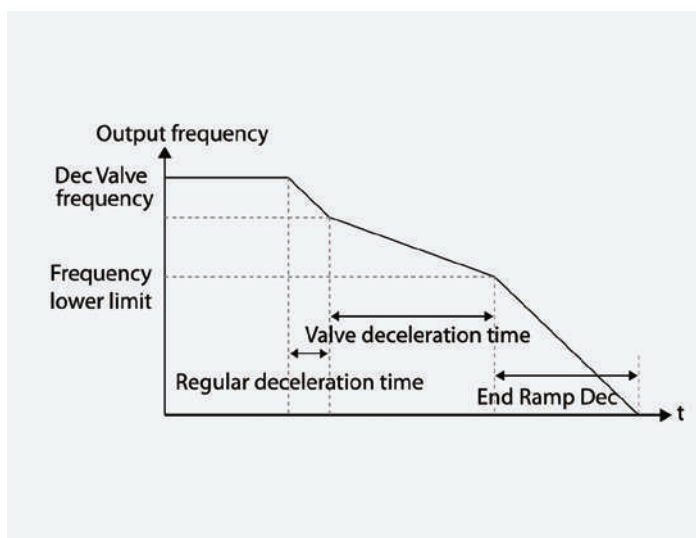

➤ **Easy-to-Change Cooling Fan**

It is easy to change a cooling fan without opening the cover of the drive.



➤ **Flange-Type Mounting**

If the space is too small, a heat sink can be installed outside the panel. This helps reduce heat losses inside the panel.

➤ **Side-by-Side Installation**

The size of the control board is significantly reduced when multiple drives are installed by minimising the distance between them.
 (Side-by-side installation is unavailable for 37~90kW)



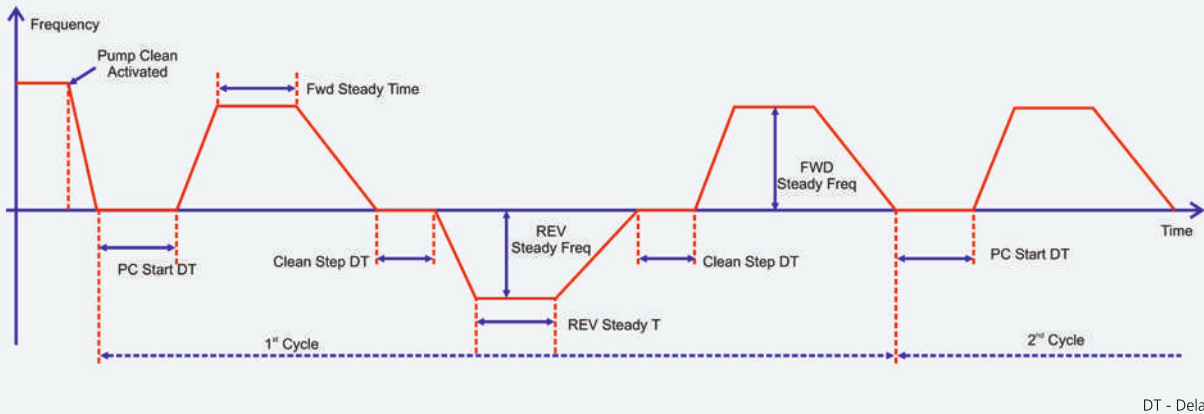

➤ Pump Clean Function

Scraps and deposits that get built up in impellers inside pumps, decrease the efficiency of a motor's performance. Through consecutive FWD/REV or ACC/DEC operations, the scraps get eliminated. This results in extension of the pump's lifespan, prevents pre-mature pump failure and ensures energy savings. The Pump Clean mode is initiated by a remote signal, current profile or power profile.

➤ Payback Counter (Energy Saving Display)

It displays energy saving information by comparing the average energy efficiency for operation with and without the drive. The energy saving information is displayed as kWh, saved energy cost and CO₂ emission level.

➤ Load Tuning

Establishes load (current and power) curves based on the drive frequency, so as to make the load characteristics curve required for 'Under Load' and 'Pump Clean' modes.

➤ Fire Mode

This function is used to allow the inverter to ignore minor faults during emergency situations, such as fire and provides continuous operation to protect other systems.

➤ Detection of Broken Pipe

This function detects pipe breaks when the PID operation is ON. The fault trip or a warning signal will occur if the feedback does not reach the level set by the user during the operation with the maximum output (PID maximum output or the maximum speed set).

➤ Aux Motor PID Compensation

In-pipe flow increases and conduit pressure decreases as the number of auxiliary motors increases. To counter this, Aux Motor PID Compensation is used to compensate for the pressure loss.

➤ Power-on Resume

When the drive restarts after it was stopped due to power interruption, the drive memorises the status command, frequency reference and ACC/DEC time settings upon loss of communication control. As soon as power is resumed, 'Power-on Resume' is used to follow the previous control command.

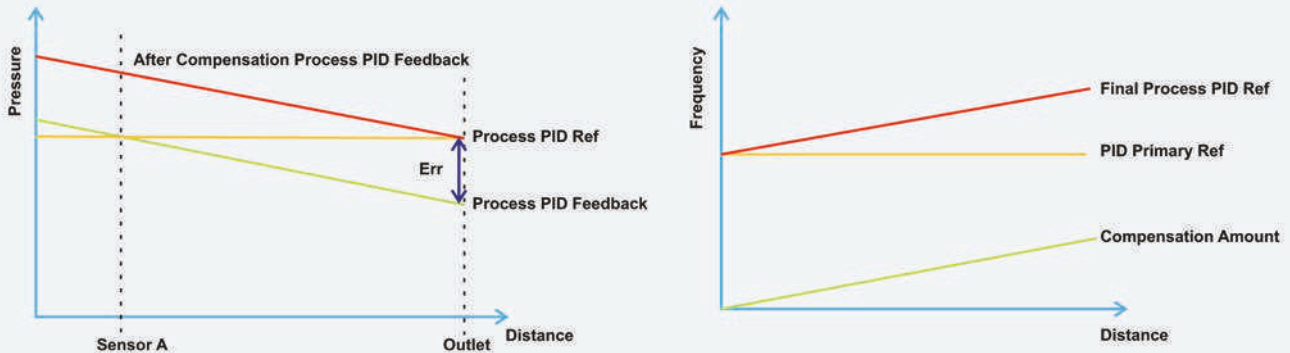

› Flow Compensation

In a system with longer pipes and a higher flow rate, a drop in pressure is often experienced. This feature helps to compensate for the pressure drop by increasing the PID reference.

› Lubrication Control

During a lubrication operation, the drive outputs the lubrication signal through one of the output relays when the drive receives a RUN command. The drive does not start operating until the time set at 'Lubrication OP Time' has elapsed and the Lubrication signal is turned OFF.

› Damper Control

If a fan and a damper are used together in a system, the drive may be configured to operate according to the damper's operation status. During damper operation, one of the relay outputs (Relay 1–5) may be set to 'Damper Control' to output a signal based on the damper's operation status. One of the multi-function terminal inputs may also be set 'Damper Open' to receive the damper status input. The drive starts operating when both the RUN command and the 'Damper Open' signal are turned ON.

› Pre-Heat Function

Pre-heats motors by outputting direct current when the motors or pumps are not in operation, in order to prevent condensation of the motors or pumps.

› Level Detection

When the drive is operated above or below the user defined values i.e., beyond the set frequency and source (voltage, current) values the drive generates a trip or activates a relay for protective operation.

› Macro Setting

The Macro selection function is used to put various application functions together in a group. For applications with the Hx2000 drive, 7 Macro configurations are available i.e. Basic, Compressor, Supply Fan, Exhaust Fan, Cooling Tower, Circulation Pump, Vacuum Pump and Constant Torque.

› PID Sleep and Wake-up function

It is used to put the drive on standby and restart it using PID as per the load requirement in order to reduce motor losses as much as possible.

Communication Module

Built-in RS485 communication: • **BACnet** • **Modbus-RTU** • **Metasys N2**
Optional: **LonWorks**

Software Exclusive for E&A Drives

DriveConnect can be connected using USB Port or RJ45 terminal.

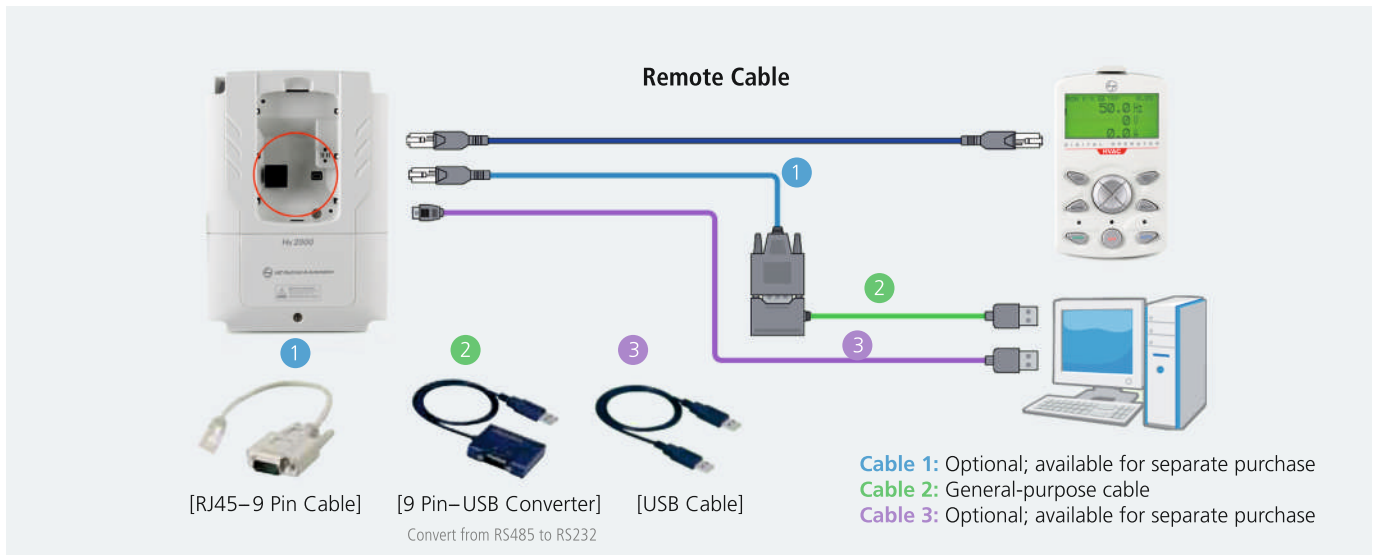

Optional I/O Expansion Card

Expansion I/O 1 (LTIO-EXP-H) card
This can be installed as an option with the following specifications:

- Digital Inputs: 2 (NPN/PNP)
- Digital Outputs: 3 (Relay)
- Analog Input: 1 (V/I)*
- Analog Output: 1 (V/I)*

Expansion I/O 2 (LTIO-EXP2-H) card

- Analog Input: 3 (V/I)*
- Analog Output: 2 (1V & 1I)*

*V = 0-10 V, I = 0-20mA

➤ Hx2000 with I/O Expansion card 1

I/O type	Standard	IO Expansion Card	Total
DI	7	2	9
DO	5R+1T	3	9
AI	1V+1V/I	1V/I	3
AO	1V+1V/I	1V/I	3
PTI	1	0	1
PTO	1	0	1

➤ Hx2000 with I/O Expansion card 2

I/O type	Standard	IO Expansion Card	Total
DI	7	0	7
DO	5R+1T	0	6
AI	1V+1V/I	3V/I	5
AO	1V+1V/I	1V + 1I	4
PTI	1	0	1
PTO	1	0	1

➤ Input and Output Specifications: Input Voltage Three-Phase 415V (0.75 to 90kW - ND)

LTVF-H4□□□□BAA			0002	0004	0006	0008	0012	0016	0024	0030	0038	0045	0061	0075	0091	0107	0142	0169
Applied Motor (kW)	kW		0.75	1.5	2.2	3.7	5.5	7.5	11	15	18.5	22	30	37	45	55	75	90
	HP		1.0	2.0	3.0	5.0	7.5	10	15	20	25	30	40	50	60	75	100	120
Output Ratings	Rated Current [A]	ND	2.5	4	6	8	12	16	24	30	38	45	61	75	91	107	142	169
	Rated Capacity [kVA]		1.9	3.0	4.5	6.1	9.1	12.2	18.3	23.0	29.0	34.3	46.5	57.1	69.4	82.0	108.2	128.8
	Output Frequency		0 ~ 400 [Hz]															
	Output Voltage [V]		3-phase 380 ~ 480V															
Input Ratings	Available Voltage [V]		3-phase 380 ~ 480 VAC (-15%, +10%)															
	Input Frequency		50 ~ 60 [Hz] (±5%)															
	Rated Current [A]	ND	2.4	4.2	6.5	8.7	12.2	17.5	26.5	33.4	42.5	50.7	69.1	69.3	84.6	100.1	133.6	160.0

Standard Specifications	Rated Input Voltage		3-phase 380 ~ 480 VAC (-15%, +10%)		
	Rated Frequency		50 ~ 60 [Hz] (±5%)		
	Max Output Voltage		Proportional to Input Voltage		
	Max Output Frequency		0 to 400Hz		
	Keypad		LCD Detachable		
	DC Reactor		Built-in from 37 to 90kW & optional AC/DC reactor upto 30kW		
	EMC Filter		Built-in as default (Class C3) & optional (Class C1/C2)		
	Features		Multi Motor Control, Built-in RTC, USB Port, HVAC Macros, Built-in PID, Lubrication Control, Motor Pre Heat, KEB, Auto Restart, Sleep & Wake-up Function, Damper Control, Belt Broken Detection, Pump Clean Mode, Flow Compensation Mode, Dry Pump Detection, Password Protection, Payback Counter (Energy Saving on Display), Fire Mode		
Control Details	Control Method		V/F control, slip compensation		
	Frequency Setting Resolution		Digital command: 0.01 Hz Analog command: 0.06 Hz (60 Hz standard)		
	Frequency Settings		Analog type: -10~10 V, 0~10 V, 0~20 mA Digital type: keypad, pulse train input		
	V/F Pattern		Liner, squared reduction and user V/F		
	Overload Capacity		Rated current of 120% for 1 minute		
	Torque Boost		Manual torque boost, automatic torque boost 1, automatic torque boost 2		
	Output Frequency Resolution		0.01Hz		
	Accel/Decel Time		0.0 to 6000.0 (sec)		
	Frequency Accuracy		1% of maximum output frequency		
Operation	Operating Method		Selectable among keypad/terminal block/communication operation		
	Operating Functions		PID control, 3-wire operation, Frequency limit, Second motor function, Anti-forward and reverse, direction rotation, Commercial transition, Speed search, Power braking, Leakage reduction, Up-down operation, DC braking, Frequency jump, Slip compensation, Automatic restart, Automatic tuning, Energy buffering, Flux braking, Energy Saving		
	Input	Multi-function terminal P1-P7	7No. Programmable NPN (Sink) / PNP (Source)		
			Function: Forward direction operation, Reset, Emergency stop, Multi step speed, frequency-high/med/low, Reverse direction operation, External trip, Jog operation, Multi step acc/dec, Second motor selection, DC braking during stop, Frequency increase, Frequency decrease, 3-wire, Select acc/dec/stop, MMC Interlock, Frequency reduction, Fix analog command frequency, Transition from PID to general operation Pre Heat, Pump Cleaning, RTC (Time Event)		
			2 No., -10 ~ 10 Vdc : 1 No. 0 ~ 20 mA / -10 ~ 10Vdc : 1 No.		
	Pulse Train input		0 to 32 kHz		
	Output	Multi-function open collector terminal	Fault output and drive operation status output	1 No., Less than DC 26 V, 50 mA	
		Fault Signal relay		1 No.	N.O.: Less than AC 250 V 2A, DC 30 V, 3A
					N.C.: Less than AC 250 V 1A, DC 30 V 1A
		Multi-function relay		4 No., Less than AC 250 V, 5 A Less than DC 30 V, 5 A	
Analog output		2 No., 0 ~ 10 Vdc / 0 ~ 20 mA : 1 No. 0 ~ 10 Vdc : 1 No.			
Pulse Train output		0 to 32 kHz			
RS-485 Communication		Built-in BACnet, Modbus-RTU, Metasys N2 as standard			

	Rated Input Voltage	3-phase 380 ~ 480 VAC (-15%, +10%)
Protective Functions	Trip	Over-current trip, Trip caused by external signals, ARM short-circuit current trip, Overheat trip, Pipe broken trip, Input open-phase trip-Ground trip, Motor overheat trip, IO board connection trip, No motor trip, Parameter write trip, Emergency stop trip, Command loss trip, CPU watchdog trip, Motor under-load trip, Overvoltage trip, Temperature sensor trip, Drive overheat, Option trip, Output open-phase trip, Drive overload trip, Fan trip, Low voltage trip during operation, Low voltage trip, Analog input error, Motor overload trip, Keypad command loss trip, Damper trip, Level detect trip, All auxiliary motor failure trip, Pump clean failure (fault)
	Alarm	Command loss trip alarm, overload alarm, normal load alarm, drive overload alarm, fan operation alarm, resistance braking rate alarm, Capacitor life alarm, Pump Clean alarm, Fire Mode Alarm, LDT Alarm.
	Momentary Power Loss Ride through	Less than 8 ms: Continue Operation (must be within the rated input voltage and rated output range) More than 8 ms: Auto restart operation
Structure & Environment	Area of Use	Indoors. Prevent contact with corrosive gases, inflammable gases, oil stains, dust, and other pollutants (Pollution Degree 2 Environment)
	Type of Cooling	Forced fan cooling structure
	Enclosure Type	IP20 / UL Open(default), UL Enclosed Type 1(option)
	Ambient Temperature	-10°C to 40°C
	Storage Temperature	-20C ~ 65°C
	Application Humidity	Upto 95% of relative humidity (with no dew formation)
	PCB Protection	Conformal Coating complying to IEC 60721-3-3 class 3C2 (max) and class 3C3 (avg)
	Altitude	1,000m or below
	Vibration	9.8m/sec ² (1.0G) or below
Global Compliance	CE, RoHS, UL (Plenum Rated)	

0.75 to 90kW

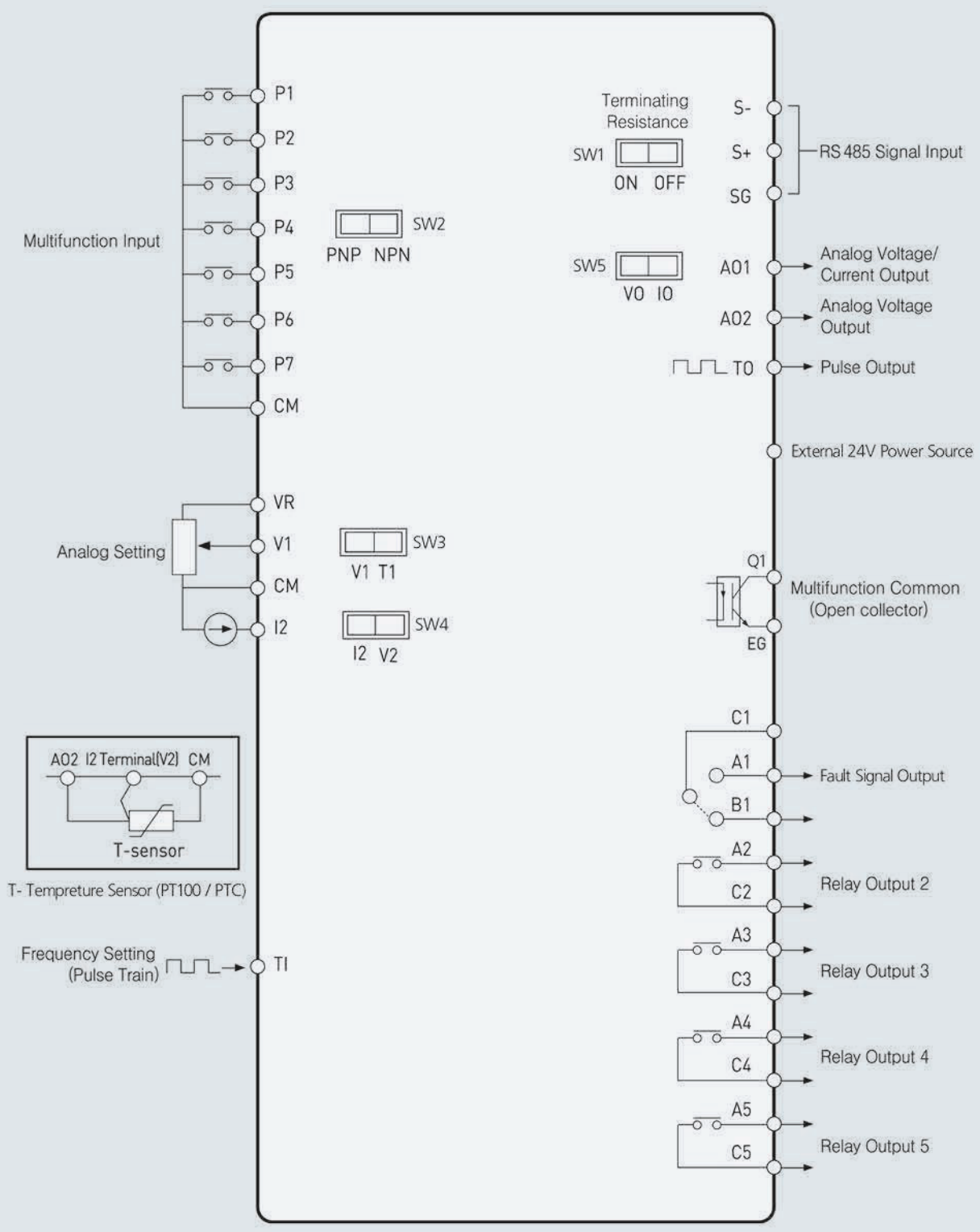

	Classification	Symbol	Name	Description
Input Terminal Details	Selection of contact points	P1~P7	Multifunctional Input 1~7 Terminal	It can be used by setting multifunctional input. Default values from the factory are as follows: <ul style="list-style-type: none"> • P1: Fx • P2: Rx • P3: BX • P4: RST • P5: Speed-L • P6: Speed-M • P7: Speed-H
		CM	Sequence Common Terminal	Common terminal of contact point input and analog I/O terminal
	Analog Input	VR	Power Terminal for Frequency Setting	Power for analog frequency setting: <ul style="list-style-type: none"> • Max. output voltage: 12V • Max. output current: 12mA • Volume resistivity: 1~10kΩ
		V1	Frequency Setting(Voltage) Terminal	Frequency is set depending on the voltage supplied to V1 terminal. <ul style="list-style-type: none"> • Unipolar: 0~10V(Max. 12V) • Bipolar: -10~10V(Max. ±12V)
		I2	Frequency Setting (Current/Voltage) Terminal	Frequency is set depending on the current capacity supplied to I2 terminal. V2 can be used by selecting analog voltage/current input terminal setting switch (SW4). <ul style="list-style-type: none"> • Input current: 0~20mA • Max. input current: 24mA • Input resistance 249Ω • Input voltage: 0~10V
Pulse Train	TI	Frequency Setting Terminal	Frequency is set as 0~32kHz. Low Level : 0~0.8V, High Level : 3.5~12V	
Output/Communication Terminal Details	Selection of contact points	Q1	Multifunctional (Open Collector) Output/ Pulse Output Terminal	As a multifunctional output signal or pulse output, one of the following is chosen: Output frequency, output current, output voltage and DC voltage. DC 26V, 50mA or below Pulse output terminal <ul style="list-style-type: none"> • Output frequency: 0~32kHz • Output voltage: 0~12V
		EG	Common Terminal	<ul style="list-style-type: none"> • Common ground terminal for external power of open collector
		24	24V Power Terminal *	<ul style="list-style-type: none"> • Max. output current: 100mA • Do not use external 24V except for PNP-mode terminal block
		A1/C1/B1	Abnormal Signal Output/Multifunctional Output Terminal	When power is cut-off to protect the product, signals or multifunctional signals are output. (N.O. : AC250V 2A or below, DC 30V 3A or below N.C. : AC250V 1A or below and DC 30V 1A or below) <ul style="list-style-type: none"> • At abnormal state: A1-C1 connected (B1-C1 disconnected) • At normal state: B1-C1 connected (A1-C1 disconnected) • Factory default value: Frequency
		A2/C2 ~ A5/C5	Multifunctional Relay Output A Contact Point	Multifunctional output terminal such as signals at operation is defined and used.(AC 250V 5A or below and DC 30V 5A or below)
	Analog Output	A01	Voltage/Current Output Terminal	One of the following is chosen and output: Output frequency, output current, output voltage and DC voltage. The following voltage/current output can be chosen by selecting analog voltage/current output terminal setting switch (SW5). <ul style="list-style-type: none"> • Output voltage: 0~10V • Max. output voltage/current: 12V, 10mA • Output current: 0~20mA • Max. output current: 20mA • Factory default value: Frequency
		A02	Voltage Output Terminal	0 ~ 10 Vdc
	Pulse Train	T0	Frequency Setting Terminal	Frequency is set as 0~32kHz. Low Level : 0~0.8V, High Level : 3.5~12V
	Communication Terminal	S+/S-/SG	RS485 Signal Input Terminal	RS485 signal line

Note: * Available only when used in PNP mode

0.75~30kW(3-Phase)

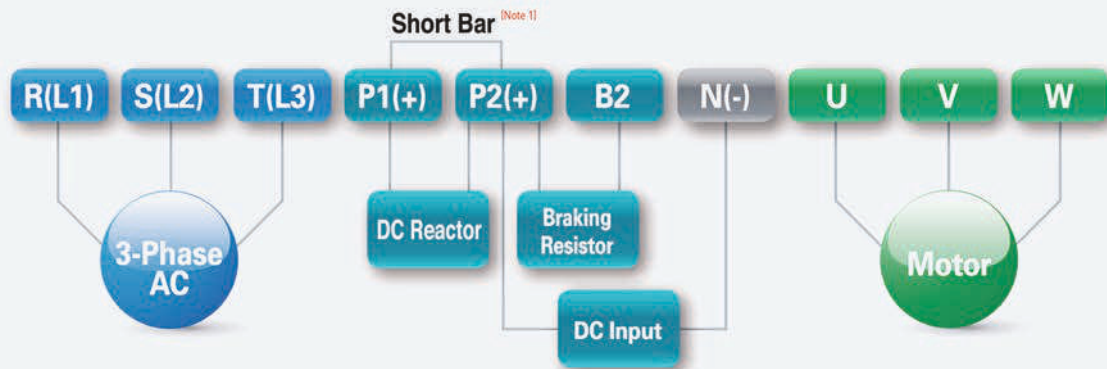

Terminal Mark	Name	Description
R(L1)/S(L2)/T(L3)	AC Power Input Terminal	It connects to commercial AC power
P1+	+DC Link Terminal	+ DC voltage terminal: This terminal is used to connect an exterior DC reactor
P2+	+DC Input Terminal	DC(+) is connected when DC is input via drive power
N-	-DC Link Terminal	DC voltage terminal: DC(-) is connected when DC is input via drive power
B2	Braking resistance connection terminal	It connects to Braking resistance ^{Note 2}
U/V/W	Motor output terminal	It connects to 3-phase induction motor

If you want to run the drive using DC input, connect DC input to P2(+) and N(-) terminal

Note 1: Short Bar should be removed when wiring DC Reactor

Note 2: In case of using with an external DC reactor, only P2(+) terminal connection is allowed

In case of not using with an external DC reactor, P1(+) or P2(+) terminal connection is allowed

37~90kW(3-Phase)

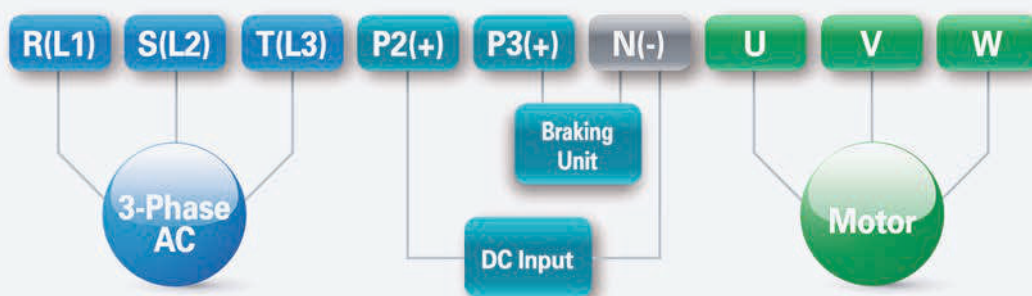

Terminal Mark	Name	Description
R(L1)/S(L2)/T(L3)	AC Power Input Terminal	It connects to commercial AC power
P2+	+DC Link Terminal	+ DC voltage terminal: DC(+) is connected when DC is input via drive power
P3+	+DC Input Terminal	+DC voltage terminal This terminal is used to connect DBU
N-	-DC Link Terminal	DC voltage terminal: DC(-) is connected when DC is input via drive power
U/V/W	Motor output terminal	It connects to 3-phase induction motor

If you wish to start the drive using DC input, connect it to the P2(+), N(-) terminal

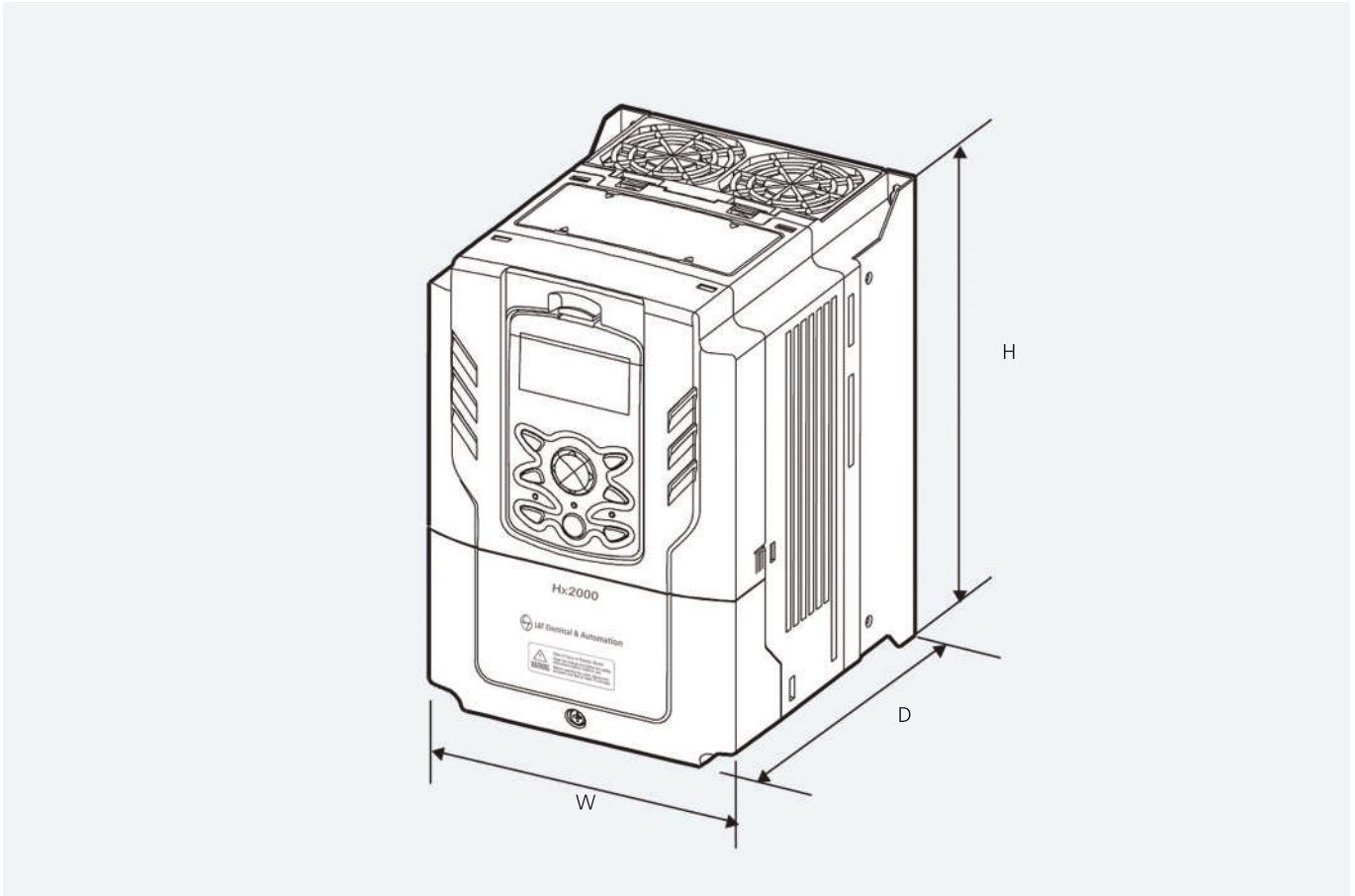

Input Voltage	Drive Model	W (mm)	H (mm)	D (mm)	Weight (kg)
Three-Phase 415 V	LTVF-H40002BAA	160	232	181	3.3
	LTVF-H40004BAA	160	232	181	3.3
	LTVF-H40006BAA	160	232	181	3.3
	LTVF-H40008BAA	160	232	181	3.3
	LTVF-H40012BAA	160	232	181	3.3
	LTVF-H40016BAA	160	232	181	3.3
	LTVF-H40024BAA	160	232	181	3.4
	LTVF-H40030BAA	180	290	205.3	4.6
	LTVF-H40038BAA	180	290	205.3	4.8
	LTVF-H40045BAA	220	350	223.2	7.5
	LTVF-H40061BAA	220	350	223.2	7.5
	LTVF-H40075BAA	275	450	284	26
	LTVF-H40091BAA	325	510	284	35
	LTVF-H40107BAA	325	510	284	35
	LTVF-H40142BAA	325	550	309	43
	LTVF-H40169BAA	325	550	309	43

Note: The above drawings are solely for reference. Please refer to the technical manual for more details.

Nx2000+



Compact, lightweight, easy to install, operate and service - the Nx2000+ Series is perfectly suited for conveyors, pumps, fans and textile machinery. It handles load up to 11 kW, and is engineered to keep your machine operating at optimum efficiency, even in the hot, humid and dusty conditions that characterise India's industrial environment.



› Main Features

- Range: 0.4kW to 11kW
- V/F, Slip Compensation, Sensorless Vector
- DIN Rail mounting for Side-by-Side installation
- Built-in EMC filter class C3 to meet IEC 61800-3
- Built-in 2 Nos multi function relays
- Integrated Potentiometer
- Built-in PID
- Built-in Braking chopper
- Torque Boost for forward & reverse direction
- Built-in 24V power source
- RPM display on keypad
- KEB for safety stop
- Auto tuning of Motor
- Conformal coating complying to IEC 60721-3-3 class 3C3 (Avg)
- Built-in RS485 Modbus RTU Communication

› Applications

- OEM Machines
- Plastic & Textile Machines
- Food & Packaging Machines
- Conveyors
- AHU Control
- Fan
- Pump
- Compressor
- Escalator
- Press Machine
- Crane Control LT / CT
- Machine Tool
- Wire Drawing



› **User Convenience**

- Built-in Potentiometer & Remote Keypad Option
- Possible to add reference from keypad & external signal
- Provides external potentiometer for easier frequency control
- Additional 0~5V analog input for frequency control
- Useful in draw mode
- Useful as auxiliary reference
- Copy parameters (Read/Write) using remote keypad

› **Easy Fan Maintenance**

You can easily replace a fan without opening the drive cover



› **Side-by-Side Installation by DIN Rail Mounting**

The panel size can be significantly reduced thanks to the Nx2000+'s DIN Rail Mounting.

› **Built in 2 No's Multi Function Relays**

Cost efficient and easy to compose system with two embedded relays.

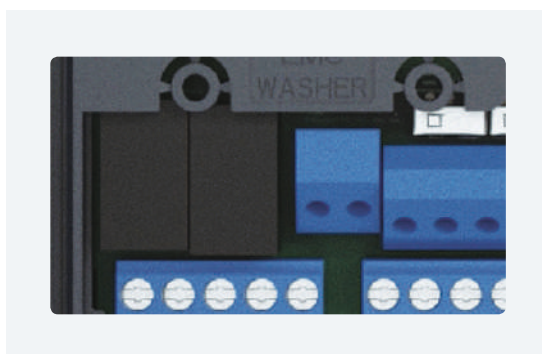

Before

Parameter	Name	Parameter Description
CON-09	PreEx Time	Initial excitation time
CON-10	Flux Force	Initial excitation amount
CON-20	Sl2 G View Sel	Sensorless gain display setting
CON-21	ASR-SL P Gain 1	Sensorless speed controller proportional gain 1
CON-22	ASR-SL I Gain 1	Sensorless speed controller integral gain 1
CON-23	ASR-SL P Gain 2	Sensorless speed controller proportional gain 2
CON-24	ASR-SL I Gain 2	Sensorless speed controller integral gain 2
CON-25	ASR-SL I Gain 0	Sensorless speed controller integral gain 0
CON-26	Flux P Gain	Flux estimator proportional gain
CON-27	Flux I Gain	Flux estimator integral gain
CON-28	S-Est P Gain 1	Speed estimator proportional gain 1
CON-29	S-Est I Gain 1	Speed estimator integral gain 1
CON-30	S-Est I Gain 2	Speed estimator integral gain 2
CON-31	ACR SL P Gain	Current controller P gain
CON-32	ACR SL I Gain	Current controller I gain
CON-54	FWD + Trq Limit	Positive-direction reverse torque limit
CON-55	FWD - Trq Limit	Positive-direction regeneration torque limit
CON-56	REV + Trq Limit	Negative-direction reverse torque limit
CON-57	REV - Trq Limit	Negative-direction regeneration torque limit
CON-85	Flux P Gain 1	Flux estimator proportional gain 1
CON-86	Flux P Gain 2	Flux estimator proportional gain 2
CON-87	Flux P Gain 3	Flux estimator proportional gain 3
CON-88	Flux I Gain 1	Flux estimator integral gain 1
CON-89	Flux I Gain 2	Flux estimator integral gain 2
CON-90	Flux I Gain 3	Flux estimator integral gain 3
CON-91	SL Volt Comp 1	Sensorless voltage compensation 1
CON-92	SL Volt Comp 2	Sensorless voltage compensation 2
CON-93	SL Volt Comp 3	Sensorless voltage compensation 3
CON-94	SL FW Freq	Sensorless field weakening start frequency
CON-95	SL Fc Freq	Sensorless gain switching frequency

➤ Simplified SLVC Setup

Tuning parameters reduced to 6 Nos

After

Parameter	Name	Parameter Description
CON-21	Out Trq. Comp. Gain at Low Spd.	Output Torque Compensation Gain at Low speed
CON-22	Out Trq. Comp. Gain	Output Torque Compensation Gain
CON-23	Spd. Comp. Sub Gain	Speed Compensation Subsidiary Gain
CON-24	Spd. Comp. Main Gain	Speed Compensation Main Gain
CON-29	Spd. Comp. Gain at No-load	Speed Compensation Gain at No-load
CON-30	Spd. Response Adjustment Gain	Speed Response Adjustment Gain

➤ Easy Modbus Communication Connection

2 type of connection of Modbus communication

- RJ45 Port
- I/O (S+, S-)
- Communication Speed - upto 115 kbps

Fieldbus Options

Provides various communication options with simple mounting structure

- Dual Port Ethernet/IP, Modbus TCP, RAPIenet
- Profibus-DP
- CANopen

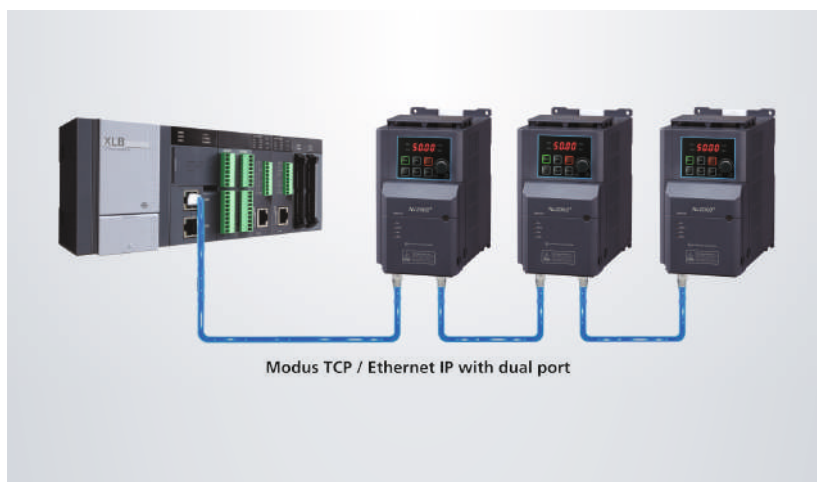



➤ **PC Tools (Drive Connect)**

- New version PC tool
- Connecting multiple drives
 - Integrated control console
 - Offline editing function
 - Data upload/download
 - 8-channel oscilloscope
 - Trigger function

➤ **V/F Accelerate and Decelerate Function**

Applied ATB & Flux braking function

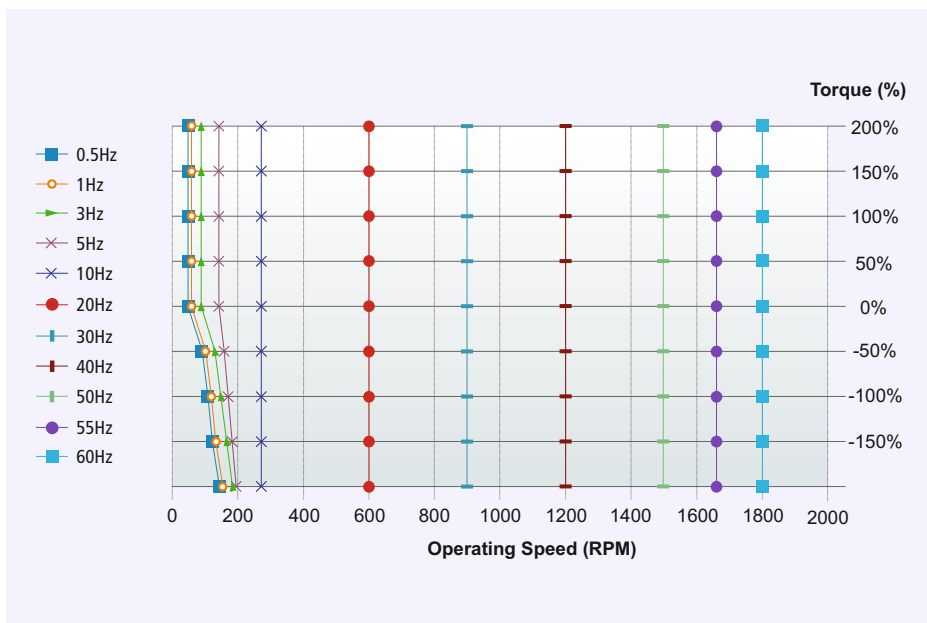
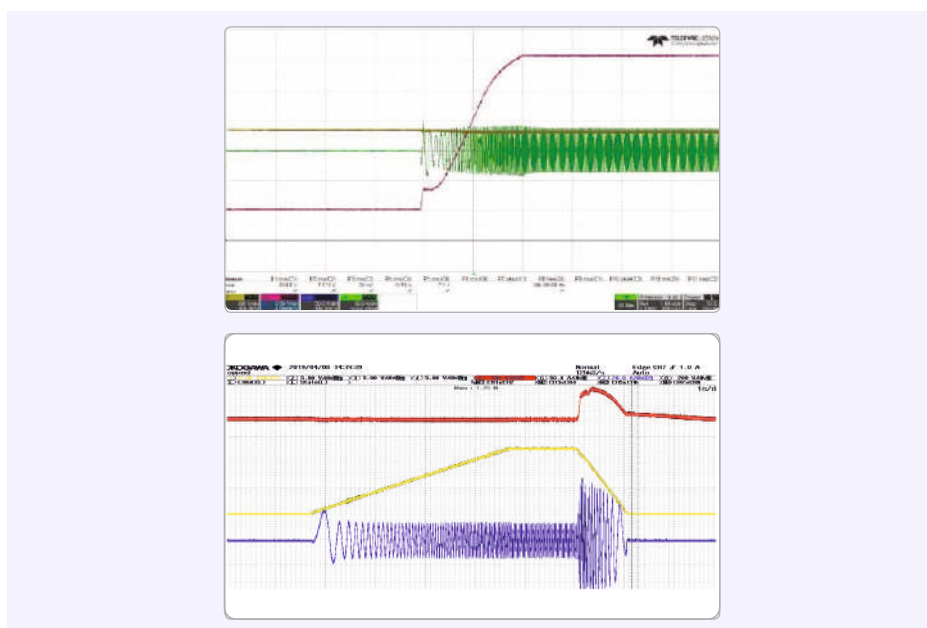

➤ **Sensorless Performance**

- Low speed/High torque
- Speed regulation +/-1% under load change
- 0.5Hz 200% peak torque

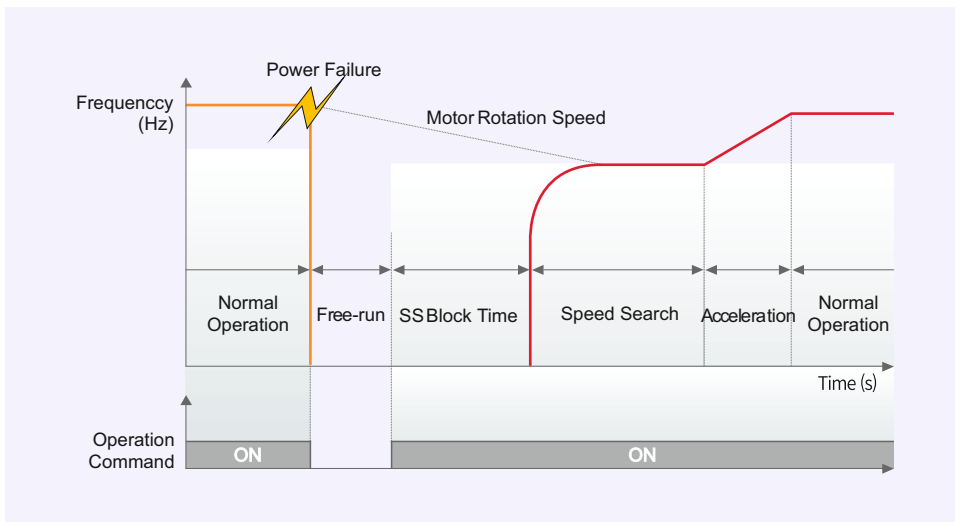

› KEB for Safe Operating Stop

- KEB for controlled stop in case of power loss or failure, for different speeds.
- User has choice to start from zero speed or same speed

Flying Start

- Select optimal flying start operation for different applications

› Built-in PID

- Useful in Pump, AHU applications to maintain process variables (Flow, Pressure & Temperature) as per required set-point.
- Available with sleep & wake-up functions
- No need for external PID Controller

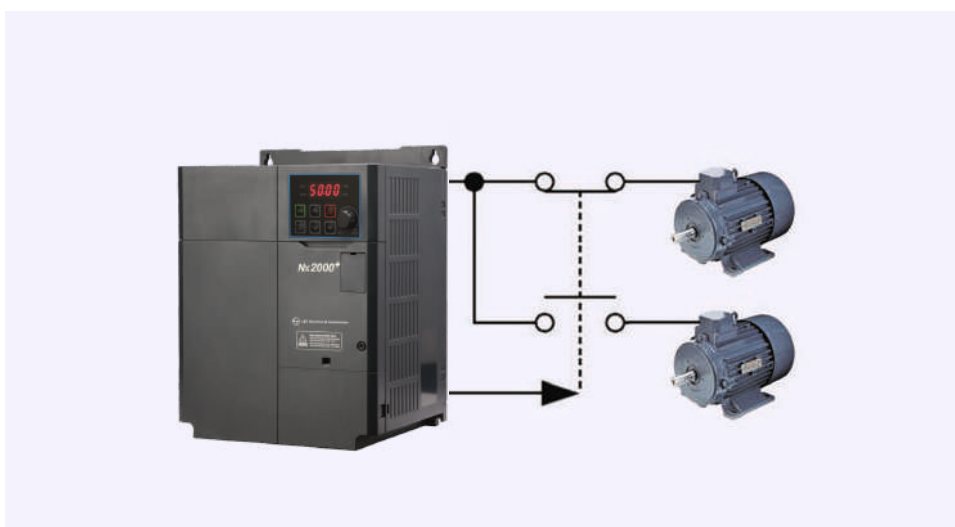
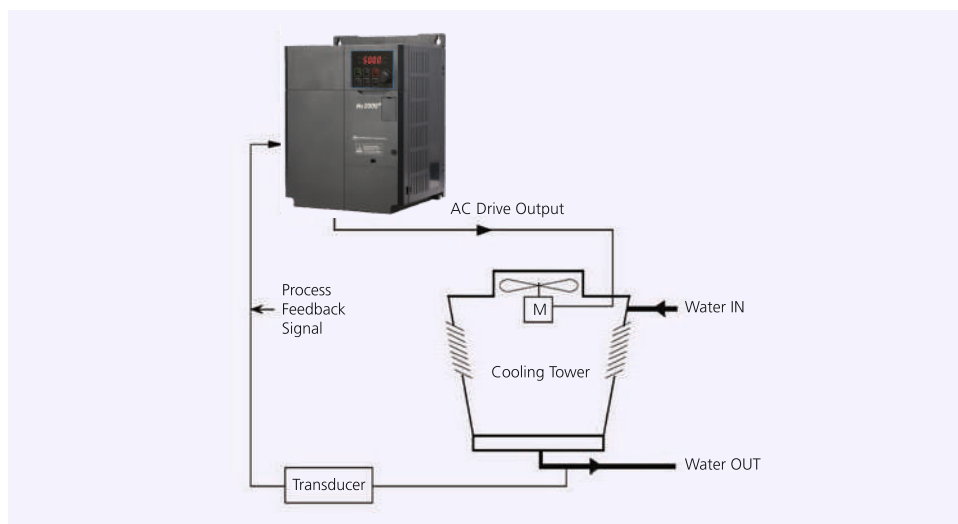

› 2nd Motor Operation

- Useful when drive operates 2 motors connected to two different types of loads
- Single AC Drive can maintain 2 motor parameters with different Accel / Decel parameter setting. It does not drive 2 motors at the same time.
- For isolated operation of motors one VFD can be used in place of 2

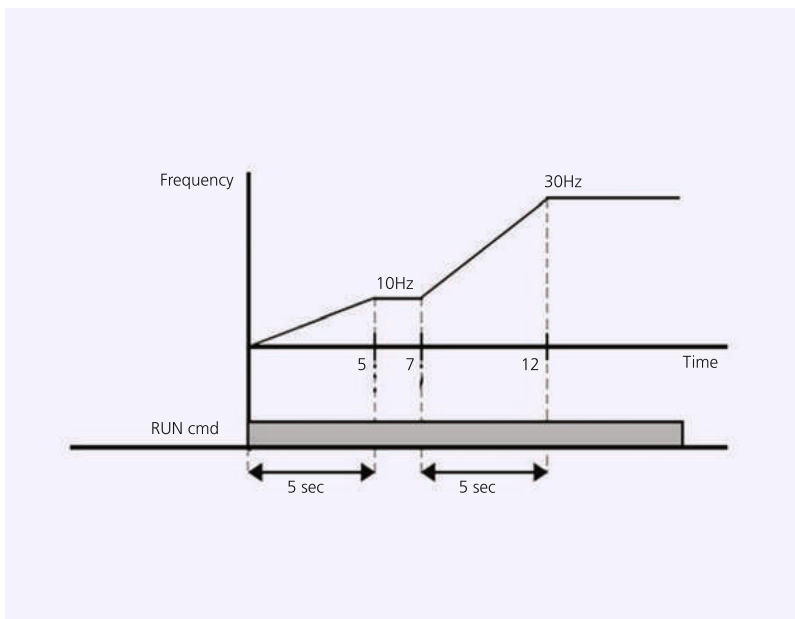

➤ **Delta Frequency: Acceleration & Deceleration control**

- Useful in standalone as well as process applications
- Acc-Dec time based on Delta frequency is normally used in process lines where gear ratio between one station to another station is different
- In applications where there are multiple drives running at different frequencies and application demands all the drives reach prescribed frequency at the same time, delta frequency is used.
- Settable from 0.00 sec to 6000 sec

➤ **Fan Life Diagnosis**

Displays fan replacement warning message with digital output or keypad

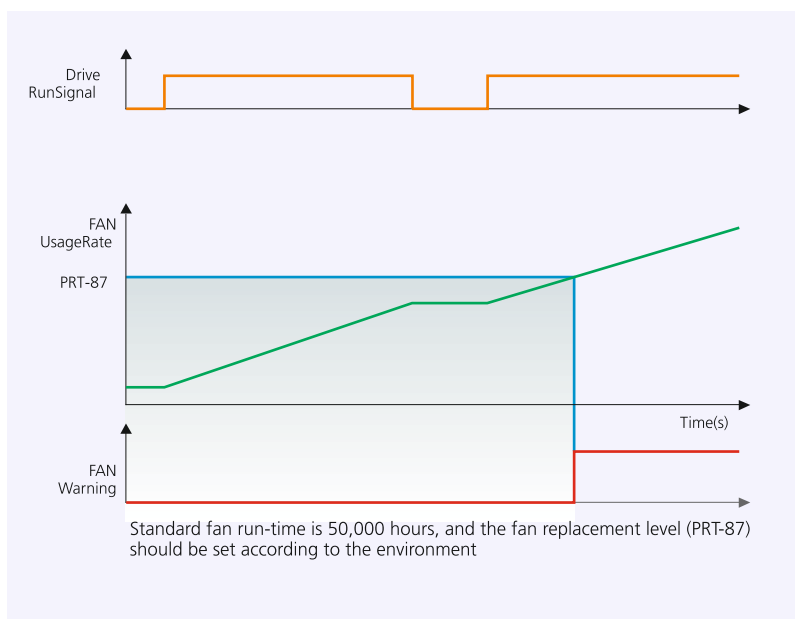

➤ **UL 61800-5-1 Design**

Satisfied the new UL certification

➤ **Built-in EMC Filter**

Embedded EMC filter to meet IEC 61800-3 standards for noise reduction

➤ **Material Design**

Enhanced thermal resistance and intensity through upgraded materials, Increased thickness to prevent damage

➤ **MIL 217Plus based Design**

Reliability design basis tool (PSA, Fr-FMEA, FTA, RBD, PBS) Improved circuit robustness through strict quality margins

➤ **Input and Output Specifications: Input Voltage Three-Phase 230V (0.75 to 11kW) - ND**

Model LTVF-N2 □□□□ BAA			03P1	06P0	09P6	12P0	18P0	30P0	40P0
Applied motor	Heavy load	HP	0.5	1.0	2.0	3.0	5.0	7.5	10.0
		kW	0.4	0.75	1.5	2.2	4.0	5.5	7.5
	Normal load	HP	1.0	2.0	3.0	5.0	7.5	10.0	15.0
		kW	0.75	1.5	2.2	3.7	5.5	7.5	11.0
Rated output	Rated capacity (kVA)	Heavy load	1.0	1.9	3.0	4.2	6.5	9.1	12.2
		Normal load	1.2	2.3	3.8	4.6	6.9	11.4	15.2
	Rated current [3-Phase input] (A)	Heavy load	2.5	5.0	8.0	11.0	17.0	24.0	32.0
		Normal load	3.1	6.0	9.6	12.0	18.0	30.0	40.0
	Rated current [1-Phase input, 230V] (A)	Heavy load	1.5	2.8	4.6	6.1	9.3	12.8	17.4
		Normal load	2.0	3.6	5.9	6.7	9.8	16.3	22.0
	Output frequency		0~400Hz (IM Sensorless: 0~120Hz)						
Output voltage (V)		3-phase 200-240 V							
Rated input	Working voltage (V)		3-phase 200-240 VAC (-15% to +10%)						
	Input frequency		50~60Hz (±5%)						
	Rated current [3-Phase input] (A)	Heavy load	2.2	4.9	8.4	11.8	18.5	25.8	34.9
Normal load		3.0	6.3	10.8	13.1	19.4	32.7	44.2	
Weight (kg)			1.04	1.06	1.36	1.4	1.89	3.08	3.21

➤ **Input and Output Specifications: Input Voltage Three-Phase 415V (0.75 to 11kW) - ND**

Model LTVF-N4 □□□□ BAA			02P0	03P1	05P1	06P9	10P0	16P0	23P0
Applied motor	Heavy load	HP	0.5	1.0	2.0	3.0	5.0	7.5	10.0
		kW	0.4	0.75	1.5	2.2	4.0	5.5	7.5
	Normal load	HP	1.0	2.0	3.0	5.4	7.5	10.0	15.0
		kW	0.75	1.5	2.2	3.7	5.5	7.5	11.0
Rated output	Rated capacity (kVA)	Heavy load	1.0	1.9	3.0	4.2	6.5	9.1	12.2
		Normal load	1.5	2.4	3.9	5.3	7.6	12.2	17.5
	Rated current [3-Phase input] (A)	Heavy load	1.3	2.5	4.0	5.5	9.0	12.0	16.0
		Normal load	2.0	3.1	5.1	6.9	10.0	16.0	23.0
	Rated current [Phase-Phase input, 415V] (A)	Heavy load	0.7	1.4	2.1	2.8	4.9	6.4	8.7
		Normal load	1.3	1.9	2.8	3.6	5.4	8.7	12.6
	Output frequency		0~400Hz (IM Sensorless: 0~120Hz)						
Output voltage (V)		3-phase 380-480 V							
Rated input	Working voltage (V)		3-phase 380-480 VAC (-15% to +10%)						
	Input frequency		50~60Hz (±5%)						
	Rated current [3-Phase input] (A)	Heavy load	1.1	2.4	4.2	5.9	9.8	12.9	17.5
Normal load		2.0	3.3	5.5	7.5	10.8	17.5	25.4	
Weight (kg)			1.04	1.08	1.44	1.46	1.98	3.24	3.28

Control

Control Method	V/F, Slip Compensation, Sensorless Vector
Frequency Setting Resolution	Digital command : 0.01Hz Analog command : 0.05Hz
Frequency Accuracy	1% of the maximum output frequency
V/F Pattern	Linear, squared, user V/F
Overload Capacity	HD:150% for 1 minute, ND: 120% for 1 minute
Torque Boost	Manual/Automatic torque boost

Operation

Operation Mode	Select keypad, terminal strip, or communication operation	
Frequency Setting	Analog: -10~10[V], 0~10[V], 4~20[mA] Digital : Keypad	
Operation Function	PID control, 3-wire operation, Frequency limit, Second function, Anti-forward and reverse direction rotation, Commercial transition, Speed search, Power braking, Leakage reduction, Frequency up/down operation, DC braking, Frequency jump, Slip compensation, Automatic restart, Automatic tuning, Energy buffering, Flux braking, Fire mode	
Input	Multi-Function Terminal (5 Points)	NPN (Sink) / PNP (Source) Selectable Function: Forward run, Reverse run, Reset, External trip, Emergency stop, Jog operation, Multi-step frequency-high, middle, low, Multi-step acceleration/deceleration-high, middle, low, DC braking at stop, 2nd motor select, Frequency up/down, 3-wire operation, change into normal operation during PID operation, Analog command frequency fixing, Acceleration/deceleration stop etc. selectable
	Analog Input	V1:-10~10V, I2: 4~20mA
Output	Multi-function Relay Terminal	Fault output and drive operation status output (N.O., N.C.) less than AC 250V 1A, less than DC 30V 1A
	Analog Output	0~12Vdc: Frequency, Output current, Output voltage, DC link voltage etc. selectable

Protective Function

Trip	Over current trip, external signal trip, ARM short current fault trip, Over heat trip, input phase loss trip, ground trip, motor over heat trip, I/O board link trip, no motor trip, parameter writing trip, emergency stop trip, command loss trip, CPU watchdog trip, motor light load trip Over voltage trip, temperature sensor trip, inverter over heat, option trip, output image trip, inverter overload trip, fan trip, pre-PID operation failure external brake trip, low voltage trip during operation, low voltage trip, analog input error, motor overload trip, over torque trip, under torque trip
Alarm	Command loss trip warning, overload warning, light load warning, inverter overload warning, fan operation warning, braking resistance braking rate warning, rotor time constant tuning error, inverter pre-overheat warning, over torque warning, under torque warning
Momentary Power Loss	HD below 15ms (ND below 8ms): Continuous operation (To be within rated input voltage, rated output) HD above 15ms (ND above 8ms): Automatic restart operation enable

Environment

Cooling Type	Forced fan cooling structure
Enclosure Type	IP20/UL Open (Default), UL Enclosed type 1 (Option)
Conformal Coating	Complies to IEC 60721-3-3 class 3C3 (Avg)
Ambient Temperature	Ambient temperature under the condition of no ice or frost. HD: -10~50°C(14~122°F) / ND: -10~40°C(14~104°F) [However, recommended to use load upto 80% when using Normal Duty rating at 50° C]
Humidity	Upto 95% of relative humidity (with no dew formation)
Storage Temperature	-20~65°C (-4~149°F)
Location	No corrosive gas, flammable gas, oil mist and dust etc. indoor (Pollution degree 2 environment)
Altitude, Vibration	Below 1,000m (From 1000 to 4000m, the rated input voltage and rated output current of the drive must be derated by 1% for every 100m.), below 9.8m/sec ² (1G)
Pressure	70~106 kPa

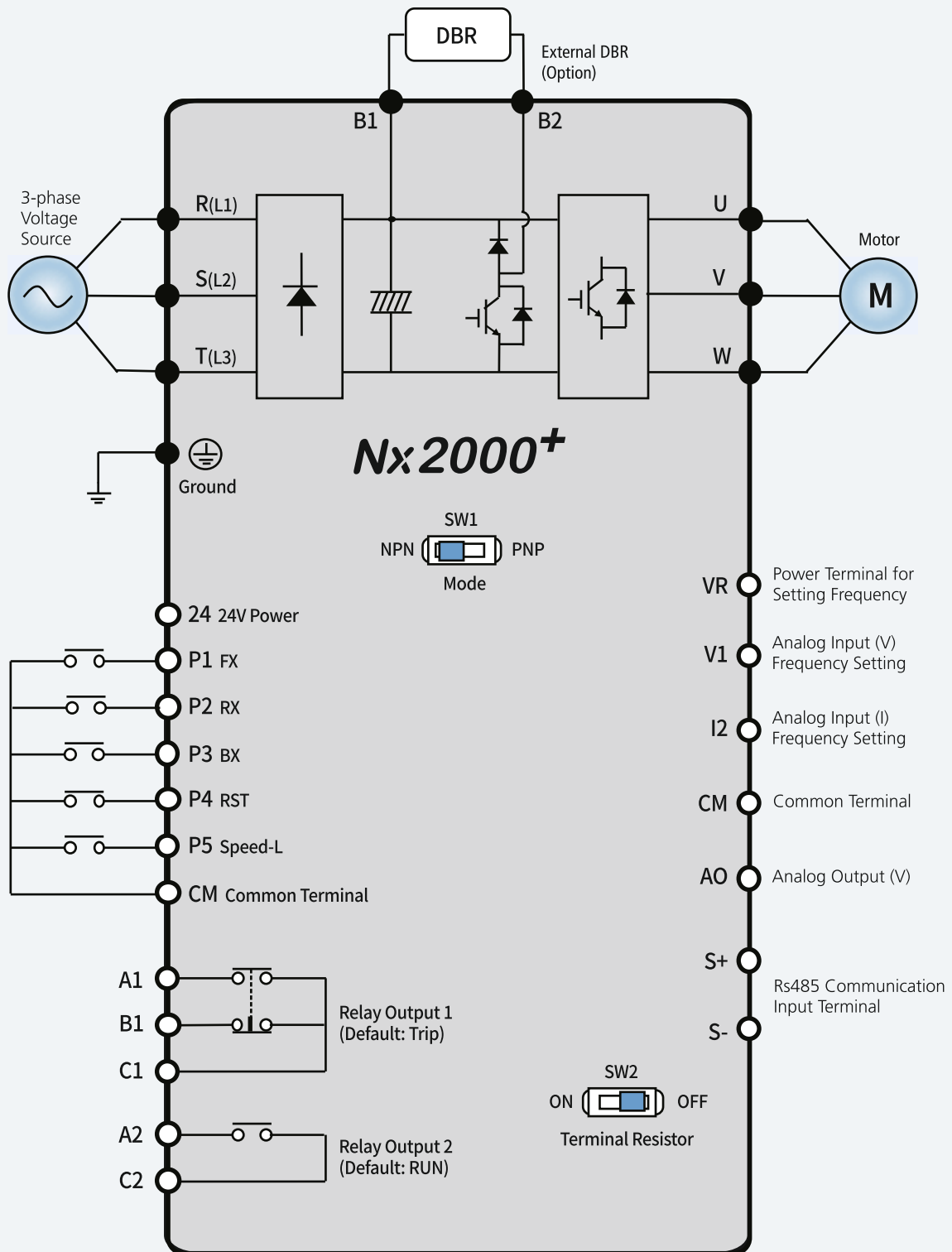

0.4/0.75kW

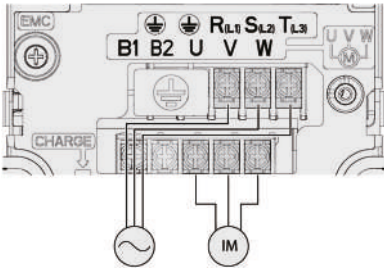

1.54/2.2kW

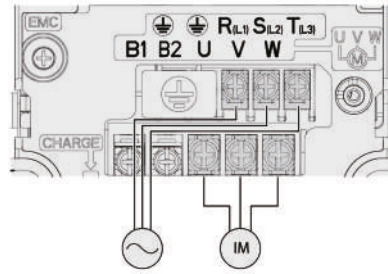

4.0kW

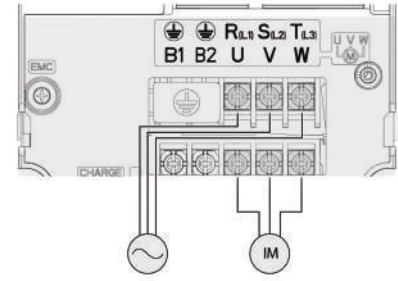

5.5/7.5kW

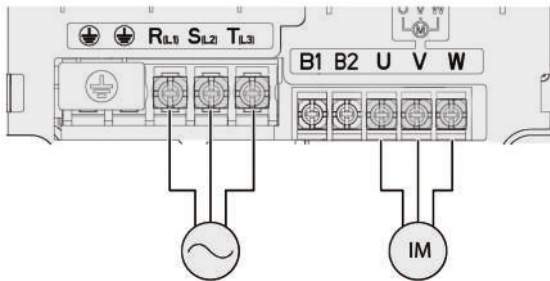

Terminal Labels	Name	Description
⊕	Ground terminal	Connect earth grounding
R(L1)/S(L2)/T(L3)	AC power input terminal	Mains supply AC power connections
B1/B2	Brake resistor terminals	Brake resistor wiring connection
U/V/W	Motor output terminals	3-phase induction motor wiring connections

Capacity (kW)		Terminal Screw Size	Rated Screw Torque (Kgf.cm/Nm)
3-Phase 230V Class	0.4	R/S/T, U/V/W : M3	R/S/T, U/V/W : 5.1/0.5
	0.75		
	1.5	R/S/T, U/V/W : M4	R/S/T, U/V/W : 12.1/1.2
	2.2		
	4	R/S/T, U/V/W : M4	R/S/T, U/V/W : 18.4/1.8
	5.5		
7.5		R/S/T: 24.0/2.4 U/V/W : 15.0/1.5	
3-Phase 415V Class	0.4	R/S/T, U/V/W : M3.5	R/S/T, U/V/W : 10.3/1.0
	0.75		
	1.5		
	2.2	R/S/T, U/V/W : M4	R/S/T, U/V/W : 18.4/1.8
	4		
	5.5	R/S/T, U/V/W : M4	R/S/T: 14.3 / 1.4 U/V/W : 18.4 / 1.8
7.5			

- Only use the specified torque on the screw heads otherwise damage could occur. Loose screws can cause overheating and damage.
- Use copper wires with 600V, 75°C specification.

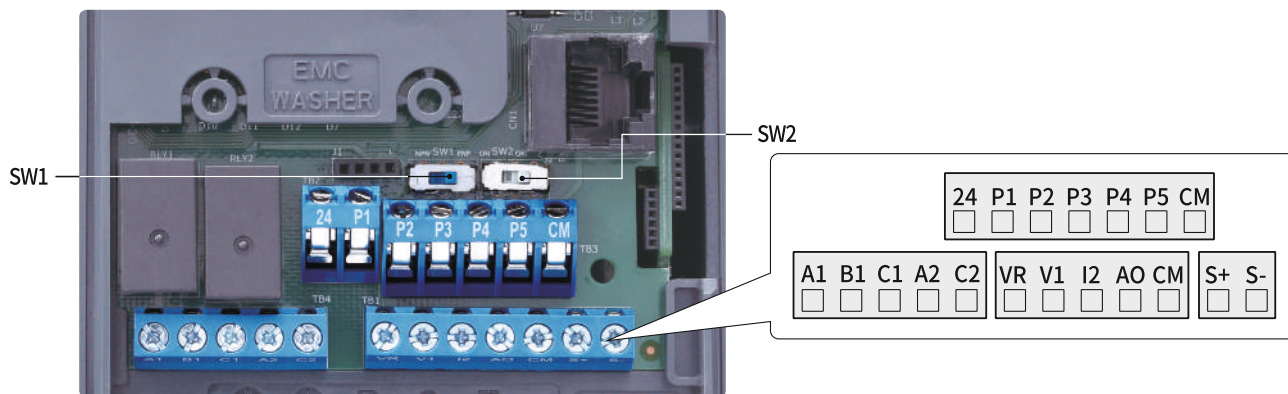

Terminals	Terminal Screw Size	Screw Torque (Kgf.cm/Nm)
P1~P5/CM/VR/V1/I2/AO/24/S+/S-	M2	2.2~2.5/0.22~0.25
A1/B1/C1,A2/C2	M2.6	4.0/0.4





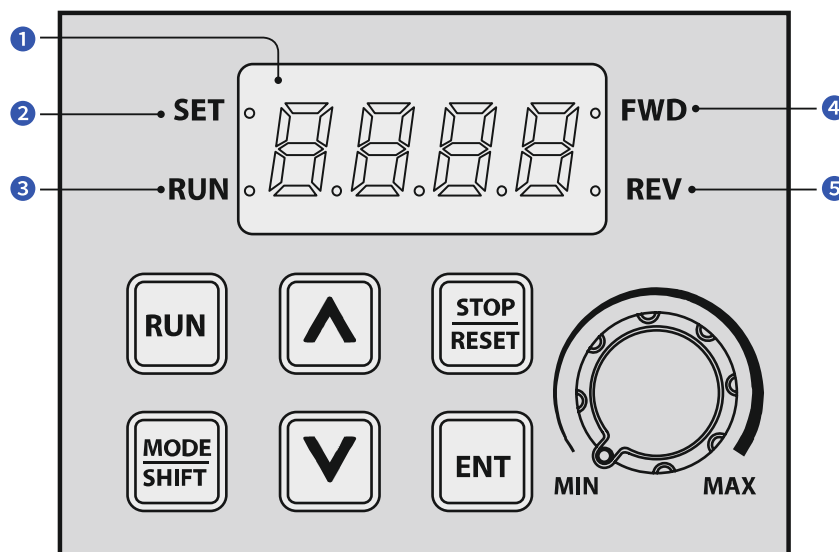





- Only use the specified torque on the screw heads otherwise damage could occur. Loose screws can cause overheating and damage.

Category	Terminal Labels	Name	Description
Multi-function Terminal Configuration	P1~P5	Multi-function Input 1-5	Configurable for multi-function input terminal. Factory default terminal ad setup are as follows. <ul style="list-style-type: none"> • P1:Fx • P2:Rx • P3:Bx • P4:RST • P5:Speed-L
	24	External 24V power source	Maximum current output: 100mA
	CM	Sequence common terminal	Common terminal for digital & analog terminal inputs and outputs.
Analog Input	VR	Potentiometer frequency reference input	Used to setup or modify a frequency reference via analog voltage or current input. <ul style="list-style-type: none"> • Maximum voltage output :12V • Maximum current output :100mA • Potentiometer :1/5kΩ
	V1	Voltage input for frequency reference input	Used to setup or modify a frequency reference via analog voltage input terminal. <ul style="list-style-type: none"> • Unipolar : 0-10V (12V Max.) • Bipolar :-10-10V (±12V Max.)
	I2	Current input for frequency reference input terminal	Used to setup or modify a frequency reference via current input terminal. <ul style="list-style-type: none"> • Input current : 4-20mA • Maximum Input current : 24mA • Input resistance: 249 Ω
Analog Output	AO	Voltage Output terminal	Used to send inverter output information to external devices: Output frequency, output current, output voltage, or a DC voltage. <ul style="list-style-type: none"> • Output voltage: 0-10V • Maximum output voltage/Current: 12V, 10mA • Factory default output: Frequency
Digital Output	A1/C1/B1	Fault signal output 1	Sends out alarm signals when the inverter's safety features are activated (AC 250V 1A, DC 30V 1A) <ul style="list-style-type: none"> • Fault condition : A1 and C1 contacts are connected (B1 and C1 open connection) • Normal operation : B1 and C1 contacts are connected (A1 and C1 open connection)
	A2/C2	Fault signal output 2	Sends out alarm signals when the inverter's safety features are activated (AC 250V 1A, DC 30V 1A) <ul style="list-style-type: none"> • Fault condition: A2 and C2 contacts are connected • Normal operation: A2 and C2 contacts are open condition
RS-485 Communication	S+/S-	RS-485 signal line	Used to send or receive RS-485 signals.



No.	Name	Function
1	7-Segment Display	Displays Current Operational status and Parameter information.
2	SET Indicator	LED flashes during parameter configuration.
3	RUN Indicator	LED turns on (Steady) during an operation, and flashes during acceleration or deceleration.
4	FWD Indicator	LED turns on (Steady) during forward operation.
5	REV Indicator	LED turns on (Steady) during reverse operation.

Key	Name	Function
	[RUN] Key	Used to run the inverter (Inputs a RUN command).
	[STOP/RESET] Key	STOP : Stops the inverter RESET : Resets the inverter if a fault or failure occurs.
	[▲] Key, [▼] Key	Switches between codes, or increases or decreases parameter values.
	[MODE/SHIFT] Key	Moves between groups or moves to the digit on the left when setting the parameter. Press the MODE/SHIFT key once again on the maximum number of digits to move to the minimum number of digits.
	[ENTER] Key	Switches from the selected state of parameter to the input state. Edits parameter and apply change. Accesses the operation information screen during failure.
	-	Escape to the initial display.
	Potentiometer or Rotating Knob	Used to set the operation frequency.

Group	Keypad Display	Description
Operation	-	Configures basic parameters for inverter operation.
Drive		Configures parameters for basic operation. These include jog operation, motor capacity evaluation, torque boost, and other keypad related Parameters
Basic		Configures basic operation parameters. These parameters include motor parameters and multi-step frequency parameters.
Advanced		Configures acceleration or deceleration patterns, frequency limits, etc.
Control		Configures sensorless vector-related features.
Input Terminal		Configures input terminal-related features, including digital multi-functional inputs and analog inputs.
Output Terminal		Configures output terminal-related features such as relays and analog outputs.
Communication		Configures communication features for RS-485 or other communication options.
Application		Configures functions related to PID control.
Protection		Configures motor and inverter protection features
Motor 2 (Secondary Motor)		Configures secondary motor related features. The secondary motor (M2) group appears on the keypad only when one of the multi-function Input terminals (In.65-In.69) has been set to 26 (secondary motor).

0.4~0.75kW (LTVF-N203P1BAA, LTVF-N206P0BAA, LTVF-N402P0BAA, LTVF-N403P1BAA)

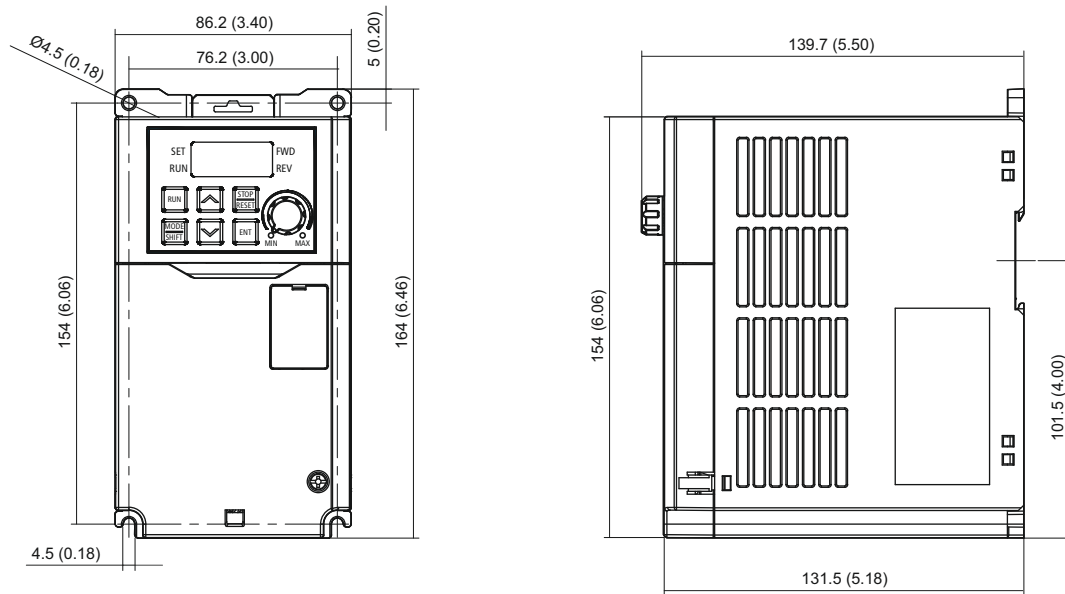

1.5~2.2kW (LTVF-N209P6BAA, LTVF-N212P0BAA, LTVF-N405P1BAA, LTVF-N406P9BAA)

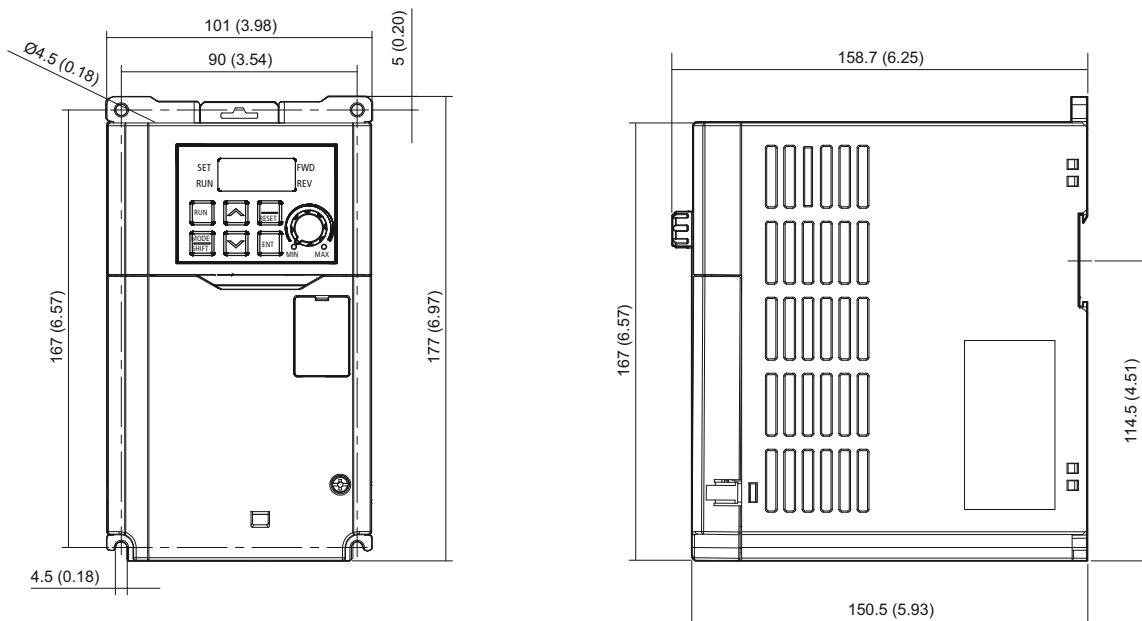

Units: mm (inches)

4.0kW (LTVF-N218P0BAA, LTVF-N410P0BAA)

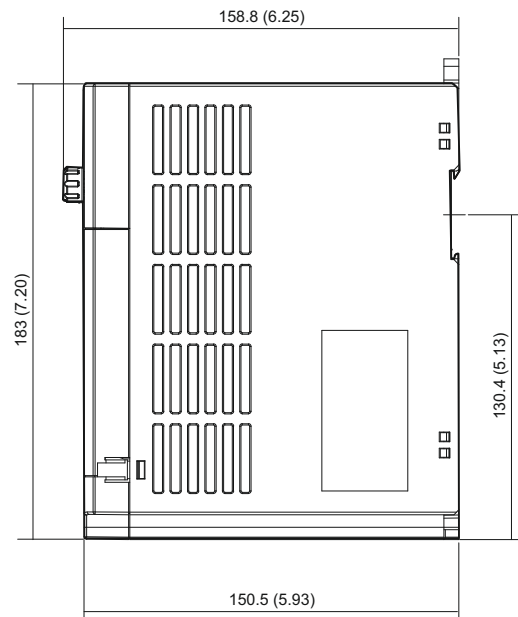
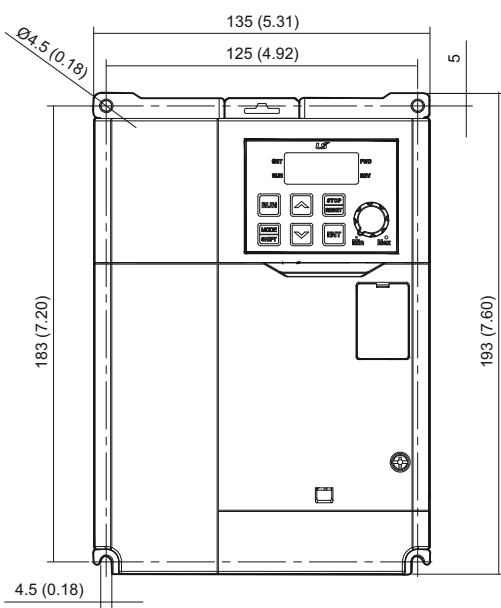

5.5~7.5kW (LTVF-N230P0BAA, LTVF-N240P0BAA, LTVFN416P0BAA, LTVF-N423P0BAA)

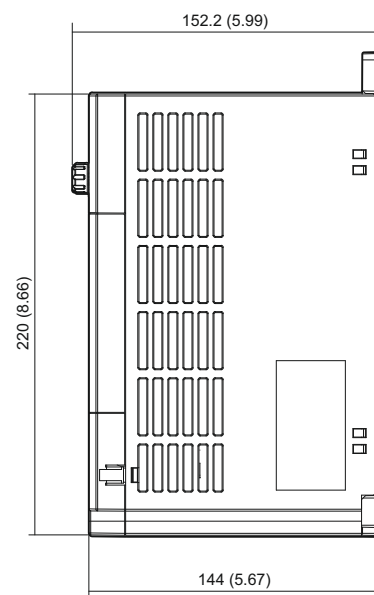
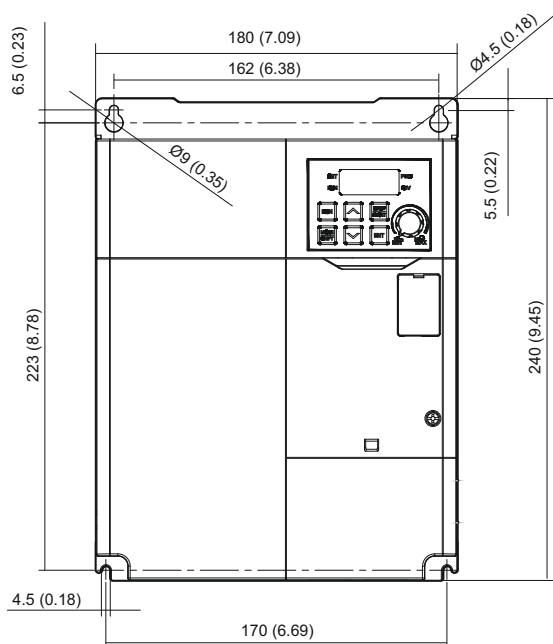

Units: mm (inches)

Nx2000



The Nx2000 series adds a new dimension to L&T Electrical & Automation (E&A)'s AC drive solutions. Built to E&A's stringent quality standards, the Nx2000 Series AC drive is tested and certified to meet global benchmarks, thus giving you the assurance of total reliability.



› Main Features

- Range: 0.2kW to 2.2kW
- V/F, Slip Compensation
- DIN Rail mounting for Side-by-Side installation
- Built-in EMC filter class C2 to meet IEC 61800-3
- Built-in 2 Nos multi function relays
- Integrated Potentiometer
- Built-in PID
- Built-in Braking chopper for 1.5kW & 2.2kW
- Torque Boost for forward & reverse direction
- Built-in 24V power source
- RPM display on keypad
- Conformal coating complying to IEC 60721-3-3 class 3C3 (Avg)
- Built-in RS485 Modbus RTU Communication

› Applications

- OEM Machines
- Plastic & Textile Machines
- Food & Packaging Machines
- Conveyors
- AHU Control
- Fan
- Pump
- Machine Tool



Built-in EMC Filter



Side-by-Side Installation
(2mm between drives)



DIN-rail Mountable

Specification

Model LTVF - N1□□□□ BAA		01P4	02P4	04P2	07P5	10P0	
Applied motor	Heavy load	HP	0.25	0.5	1.0	2.0	3.0
		kW	0.2	0.4	0.75	1.5	2.2
Rated output	Rated capacity (kVA)	0.6	0.95	1.9	3.0	4.5	
	Rated current (A)	1.4	2.4	4.2	7.5	10.0	
	Output frequency	0~400Hz					
	Output voltage (V)	3-phase 200~240V					
Rated input	Working voltage (V)	Single phase 200~240Vac (-15%~+10%)					
	Input frequency	50~60Hz(±5%)					
	Rated current (A)	1.8	3.7	7.1	13.6	18.7	
Weight (kg)		0.66	1.0		1.45		

Control

Control Method	V/F, Slip Compensation
Frequency Setting Resolution	Digital command : 0.01Hz Analog command : 0.05 Hz
Frequency Accuracy	1% of maximum output frequency
V/F Pattern	Linear, Square reduction, User V/F
Overload Capacity	150% for 1 min
Torque Boost	Manual / Automatic torque boost

Operation

Operation Mode	Select keypad, Terminal strip or Communication operation	
Frequency Setting	Analog : 0~10 [V], 4~20 [mA], 0~20 [mA] Digital : Keypad	
Operation Function	Anti-forward and reverse direction rotation, Frequency jump, Frequency limit, DC braking, Jog operation, Up-down operation, 3-wire operation, Dwell operation, Slip compensation, PID control, Energy saving operation, Speed search, Automatic restart	
Input	Multi-Function Terminal	NPN (Sink) / PNP (Source) selectable Function: Forward run, Reverse run, Reset, Emergency stop, Multi-step speed frequency-high/med/low, DC braking during stop, Frequency increase, 3-wire, Select acc/dec/stop, Reverse direction operation, External trip, Jog operation, Multi-step acc/dec-high/med/low, Second motor selection, Frequency reduction, Fix analog command frequency, Transition from PID to general operation
	Analog Input	V1: 0~10V, I2: 4~20mA or 0~20mA
Output	Multi-function relay terminal	Fault output and inverter operation status output (N.O., N.C.) less than AC 250V 1A, less than DC 30V 1A
	Analog output	0-10 Vdc: Frequency, Output current, Output voltage, DC terminal voltage etc. selectable

Environment

Ambient Temperature	-10~50°C (14~122°F), Ambient temperature under the condition of no ice or frost
Ambient Humidity	Upto 95% of relative humidity (with no dew formation)
Storage Temperature	-20~65°C(-4~149°F)
Surrounding Environment	Prevent contact with corrosive gases, inflammable gases,oil stains, dust and other pollutants (Pollution degree 2 environment)
Altitude / Oscillation	Below 1,000m, below 9.8m / sec ² (1G)
Pressure	70~106 kPa

I/O Configuration

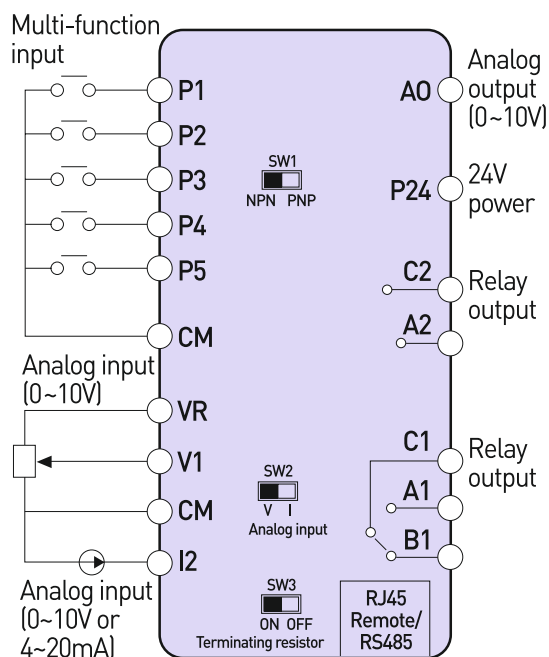

Braking Resistor Specification

Product (kW) HD	Resistance (W)	Rated Capacity (W)
1.5	60	300
2.2	50	400

* The standard for braking torque is 150% and the working rate (%ED) is 5%. If the working rate is 10%, the rated capacity for braking resistance must be calculated at twice the standard

Dimensions

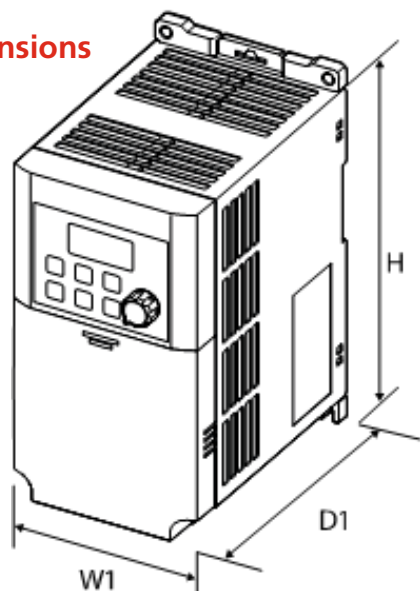

CAT No.	W1	H	D1
LTVF-N101P4BAA	85 (3.34)	135 (5.31)	100 (3.94)
LTVF-N102P4BAA		153 (6.02)	123 (4.84)
LTVF-N104P2BAA	100 (3.94)	180 (7.08)	140 (5.51)
LTVF-N107P5BAA			
LTVF-N110P0BAA			

Units: mm (inches)

Sx2000 IP66



Sx2000

 L&T Electrical & Automation

 Risk of Injury or Electric Shock.
Read the manual and follow the safety
instructions before install or use.
Before opening the cover, disconnect
all power and wait at least 10 minutes.

Sx2000 IP66 Drive provides protection against harsh environmental conditions by restricting entry of foreign substances such as fine dust and high – pressure water spray. Satisfies NEMA standard type 4X for indoor use.



› Main Features

- Range: 0.75kW to 22kW (HD)
- V/f, Sensorless vector control, Slip Compensation
- Starting Torque of 150% at 3Hz for V/f, 200% at 0.5 Hz for vector control
- Built-in Brake Control
- User Sequence – PLC functionality
- Component life monitor
- Inbuilt PID
- No motor detection
- Conformal coating complying to IEC 60721-3-3 class 3C2 (max) and class 3C3 (avg)
- Built-in RS 485 Modbus RTU communication
- Built-in braking chopper

› Applications

- Textile
- HVAC
- Pharma
- Food and Beverages
- Ceramic
- Waste Water Treatment
- Bottling plant
- Machine tool

What is IP-XX?

IP-xx denotes the degree of dust and water resistance, it is abbreviation of the IEC standard 60529 for Ingress Protection to the enclosures.

IP - **6** **6**

First Digit - SOLIDS	Second Digit - LIQUIDS
Protected against access to hazardous parts with a wire of 1mm Ø	Protected against powerful water jets from any direction
No ingress of dust - dust tight	

Front Cover Removed

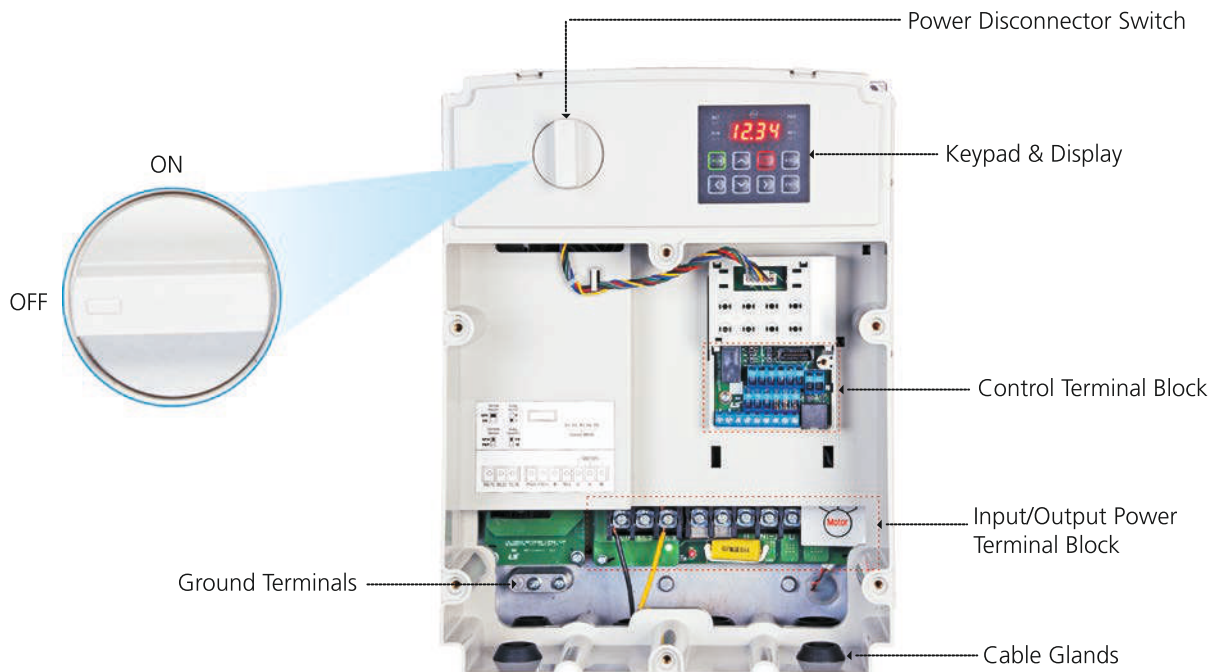

Input and output specification: **Input Voltage Three-Phase 415V (0.75 to 22kW)**

LTVF-S4 □□□□ XAA			0001	0003	0004	0006	0009	0012	0016	0024	0030	0039	0045
Applicable Motor	Heavy Duty [HD]	HP	0.5	1.0	2.0	3.0	5.5	7.5	10.0	15.0	20.0	25.0	30.0
		kW	0.4	0.75	1.5	2.2	4.0	5.5	7.5	11.0	15.0	18.5	22.0
Output Rating	Capacity [kVA]	Heavy Duty [HD]	1.0	1.9	3.0	4.2	6.5	9.1	12.2	18.3	22.9	29.7	34.3
	Rated Current [A]	Heavy Duty [HD]	1.3	2.5	4.0	5.5	9.0	12.0	16.0	24.0	30.0	39.0	45.0
	Frequency [Hz]		0~400Hz (IM Sensorless : 0~120[Hz])										
	Voltage [V]		3-phase 380~480V										
Input Rating	Voltage [V]		3-phase 380~480VAC (-15% ~ +10%)										
	Frequency [Hz]		50~60Hz (±5%)										
	Rated Current [A]	Heavy Duty [HD]	1.1	2.4	4.2	5.9	9.8	12.9	17.5	26.5	33.4	43.6	50.7

Standard Specifications	Overload Capacity	HD: 150% for 1min & 200% instantaneous for 1 second
	Max Output Voltage	Proportional to Input Voltage
	Max Output Frequency	0 to 400Hz (Sensorless: 0 to 120Hz)
	Rated Voltage	380 to 480V Three-phase (-15%/+10%)
	Rated Frequency	50/60Hz (-5%/+5%)
	Keypad	Built-in LED
	Braking Chopper	Built-in
Control Details	Control Method	V/F, Sensorless Vector Control, Slip Compensation
	Starting Torque	200% at 0.5Hz for Sensorless Control & 150% at 3Hz for V/F
	Torque Boost	Manual torque boost, Automatic torque boost
	Frequency Accuracy	1% of maximum output frequency
	Frequency Control Range	0.01 to 400Hz for V/F, 0 to 120Hz for Sensorless Vector Control
	Frequency Setting	Analog type: - 10 to 10V, +0 to 10[V], 4 to 20[mA], Digital type: Keypad, pulse train input
	Output Frequency Resolution	0.01Hz
	V/F pattern	Linear, squared, user V/F
	Accel/Decel Time	0.0 to 6000 Sec
	Braking Torque	Continuous Regeneration Torque 20% (150% with DBR)
	Features	Multi keypad, peer-to-peer communication to share I/Os, user sequence, inbuilt PID, component life monitor, no motor detection, auto tuning, Brake Control, KEB, Flying start, Safety Function
Protection	Faults	Over current trip, External signal trip, ARM short circuit current trip, Over heat trip, Ground trip, Motor over heat trip, I/O board link trip, No motor trip, Parameter writing trip, Emergency stop trip, Command loss trip, CPU watchdog trip, Motor normal load trip, Over voltage trip, Temperature sensor trip, Inverter over heat, Option trip, Output imaging trip, Inverter overload trip, Fan trip, Pre-PID operation failure, External break trip, Low voltage trip during operation, Low voltage trip, Safety A (B) trip, Analog input error, Motor overload trip
	Alarm	Command Loss trip alarm, overload alarm, normal load alarm, inverter overload alarm, fan operation alarm, resistance braking alarm, number of corrections on rotor tuning error
	Instantaneous Interruption	Heavy load less then 15ms: continue operation (must be within the rated input voltage and rated output range) Heavy load more then 15ms: auto restart operation
Interface	DI	5 (Programmable NPN/PNP)
	DO	1 (Programmable NO/NC) + 1 TR
	AI	1Nos: 0 to 10V & 1 Nos: 0 to 10V / 4 to 20mA
	AO	1 (4-20mA / 0 to 10Vdc)
	Pulse Train	1 I/P & 1 O/P (0 to 32Khz)
	Built-in PID	1
	Communication	Built-in RS485 Modbus RTU
	Safety I/P	2, complying with EN ISO 13849-1 Pld and EN61508SIL2 [EN60204-1, stop category 0]
Option	Expansion Card	3DI (PNP / NPN), 2DO (R), 2AI (-10 to 10V), (0 to 10V / 0 to 20mA), 1AO (0 to 10V / 0 to 20mA)
	Communication Card	CANopen, Profibus DP*, Profinet, Modbus TCP / Ethernet IP
Environment	Cooling Type	Forced fan cooling structure
	Area of Use	Prevent contact with corrosive gases, inflammable gases, oil stains, and other pollutants (Pollution Degree 3 Environment)
	Enclosure Type	IP66 (NEMA 4X Indoor Only)
	Ambient Temperature	-10 to 40°C for HD
	Storage Temperature	-20°C to 65°C
	PCB Protection	Conformal coating complying to IEC 60721-3-3 class 3C2(max) and 3C3(avg)
	Altitude	Below 1000m
	Vibration	9.8m/sec ² (<1G)
Global Compliance	CE, UL (Plenum Rated), RoHS	

* Profibus DP option is available from 5.5kW to 22kW

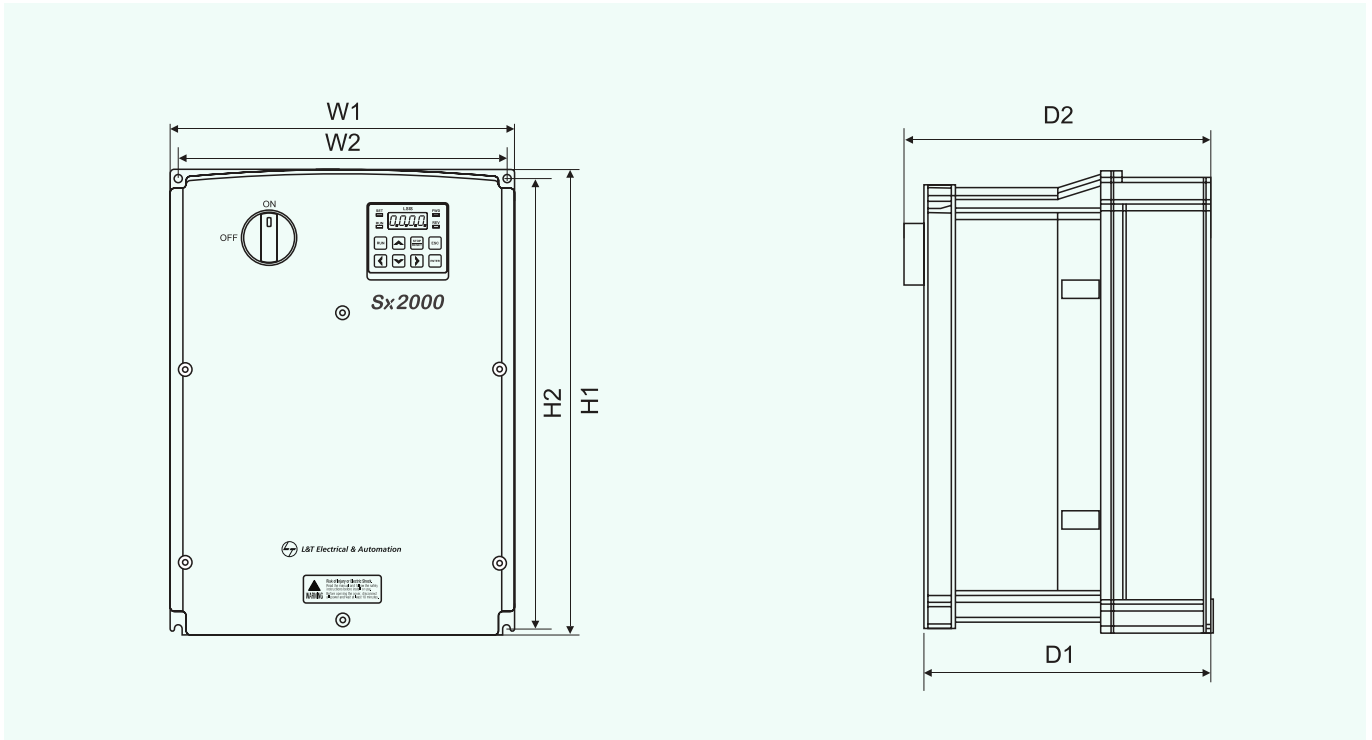

Input Voltage	Drive Cat. No.	W1 (mm)	W2 (mm)	H1 (mm)	H2 (mm)	D1 (mm)	D2 (mm)	Weight (kg)
Three-Phase 415 V	LTVF-S40001XAA	180	170	256.6	245	174.2	188.2	3.7
	LTVF-S40003XAA	180	170	256.6	245	174.2	188.2	3.7
	LTVF-S40004XAA	220	204	258.8	241	201	215	5.3
	LTVF-S40006XAA	220	204	258.8	241	201	215	5.5
	LTVF-S40009XAA	220	204	258.8	241	201	215	5.6
	LTVF-S40012XAA	250	232	328	308	227.2	241.2	8.8
	LTVF-S40016XAA	250	232	328	308	227.2	241.2	8.9
	LTVF-S40024XAA	260	229	399.6	377	245.5	259.6	9.6
	LTVF-S40030XAA	260	229	399.6	377	245.5	259.6	9.8
	LTVF-S40039XAA	300	270.8	460	436.5	250	264	12.4
LTVF-S40045XAA	300	270.8	460	436.5	250	264	12.4	

Note: The above drawings are solely for reference purposes. Please refer to the technical manual.

Accessories for AC Drives

Suitable for Drive	Description	CAT No.
Nx2000	Remote Keypad with 3m cable	LTOP-DOP-51
Nx2000+	Remote Keypad with 3m cable	LTOP-DOP-52
	CANOpen Communication Interface Card	LTCI-CAN-NP
	Ethernet IP/Modbus TCP/RAPIDnet Communication Interface	LTCI-ETH-NP
	Profibus-DP Communication Interface Card	LTCI-PDP-NP
Sx2000	LCD Digital Operator	LTOP-DOP-200
	LED Digital Operator with 3m cable for Sx2000	LTOP-DOP-150
	I/O Expansion Card for Sx2000 (3DI, 2DO, 2AI, 1AO)	LTIO-EXP-S.
	CANOpen Communication card	LTCI-CAN-S
	Profibus-DP Communication card	LTCI-PDP-S.
	Ethernet IP - Modbus TCP Communication card	LTCI-ETH-S
Fx2000	LCD Digital Operator	LTOP-DOP-200
	I/O Expansion Card 1 for Fx2000	LTIO-EX1-F
	I/O Expansion Card 2 for Fx2000	LTIO-EX2-F
	Synchronization Option Card	LTCN-SYN-F
	Position control option card for Fx2000	LTCN-PCN-F
	Incremental card for Open collector and Line Driver Encoder	LTEN-INC-F
	Profibus-DP Communication Interface card	LTCI-PDP-F
	Application Development PLC Option card	LTAD-PLC-F
	CANOpen Communication Interface card	LTCI-CAN-F
	DeviceNet Communication Interface card	LTCI-DEN-F
	Ethernet IP/Modbus TCP Communication Interface card	LTCI-ETH-F
	PLL option card for Fx2000	LTCN-PLL-F
Hx2000	I/O Expansion Card 1 for Hx2000	LTIO-EXP-H
	I/O Expansion Card 2 for Hx2000	LTIO-EXP2-H
DBU for Sx2000, Fx2000	Dynamic Braking Unit for 11 - 15kW	LTDBU-0150-4
	Dynamic Braking Unit for 18.5 - 22kW	LTDBU-0220-4
	Dynamic Braking Unit for 30 - 37kW	LTDBU-0370-4
	Dynamic Braking Unit for 45 - 55kW	LTDBU-0550-4
	Dynamic Braking Unit for 75kW	LTDBU-0750-4
	Dynamic Braking Unit for 220 - 375kW	LTDBU-2200-4

Accessories for AC Drives

Flange Options

Drive Model	Drive CAT No	Frame Size	Flange CAT Nos	Description
Sx2000	LTVF-S10003BAA	FR1	LTFM-FR1-S	FLANGE FOR S1:3A / S2:3~6A / S4:2~3A
	LTVF-S20003BAA			
	LTVF-S20006BAA			
	LTVF-S40002BAA			
	LTVF-S40003BAA			
Sx2000	LTVF-S10006BAA	FR2	LTFM-FR2-S	FLANGE FOR S1:6~10A / S2:10~12A / S4:5~7A
	LTVF-S10010BAA			
	LTVF-S20010BAA			
	LTVF-S20012BAA			
	LTVF-S40005BAA			
	LTVF-S40007BAA			
Sx2000	LTVF-S10012BAA	FR3	LTFM-FR3-S	FLANGE FOR LTVF-S10012/S20018/S40010BAA
	LTVF-S20018BAA			
	LTVF-S40010BAA			
Sx2000	LTVF-S20030BAA	FR4	LTFM-FR4-S	FLANGE FOR LTVF-S20030~40/S40016~0023BAA
	LTVF-S20040BAA			
	LTVF-S40016BAA			
	LTVF-S40023BAA			
Sx2000	LTVF-S20056BAA	FR5	LTFM-FR5-S	FLANGE FOR LTVF-S20056/S40030~0038BAA
	LTVF-S40030BAA			
	LTVF-S40038BAA			
Sx2000	LTVF-S20069BAA	FR6	LTFM-FR6-S	FLANGE FOR LTVF-S20069/S40044~0058BAA
	LTVF-S40044BAA			
	LTVF-S40058BAA			
Sx2000	LTVF-S40075BAA	FR7	LTFM-FR7-S	FLANGE FOR LTVF-S40075BAA
Sx2000	LTVF-S40091BAA	FR8	LTFM-FR8-S	FLANGE FOR LTVF-S40091~0107BAA
	LTVF-S40107BAA			
Sx2000	LTVF-S40142BAA	FR9	LTFM-FR9-S	FLANGE FOR LTVF-S40142~0169BAA
	LTVF-S40169BAA			
Fx2000	LTVF-F40004CAA	FR1	LTFM-FR1-F	FLANGE FOR LTVF-F40004~0012CAA
	LTVF-F40006CAA			
	LTVF-F40008CAA			
	LTVF-F40012CAA			
Fx2000	LTVF-F40016CAA	FR2	LTFM-FR2-F	FLANGE FOR LTVF-F40016~0024CAA
	LTVF-F40024CAA			

Accessories for AC Drives

Flange Options

Fx2000	LTVF-F40030CAA	FR3	LTFM-FR3-F	FLANGE FOR LTVF-F40030~0039CAA
	LTVF-F40039CAA			
Fx2000	LTVF-F40045CAA	FR5	LTFM-FR5-F	FLANGE FOR LTVF-F40045~0061CAA
	LTVF-F40061CAA			
Fx2000	LTVF-F40075CAA	FR6	LTFM-FR6-F	FLANGE FOR LTVF-F40075~0110CAA
	LTVF-F40091CAA			
	LTVF-F40110CAA			
Fx2000	LTVF-F40152CAA	FR7	LTFM-FR7-F	FLANGE FOR LTVF-F40152~0183CAA
	LTVF-F40183CAA			
Fx2000	LTVF-F40223AAA	FR8	LTFM-FR8-F	FLANGE FOR LTVF-F40223~0370AAA
	LTVF-F40264AAA			
	LTVF-F40325AAA			
	LTVF-F40370AAA			
Fx2000	LTVF-F40432AAA	FR9	LTFM-FR9-F	FLANGE FOR LTVF-F40432~0547AAA
	LTVF-F40547AAA			
Hx2000	LTVF-H40002BAA	FR4	LTFM-FR4-H	FLANGE FOR LTVF-H40002~0024BAA
	LTVF-H40004BAA			
	LTVF-H40006BAA			
	LTVF-H40008BAA			
	LTVF-H40012BAA			
	LTVF-H40016BAA			
	LTVF-H40024BAA			
Hx2000	LTVF-H40030BAA	FR5	LTFM-FR5-H	FLANGE FOR LTVF-H40030~0038BAA
	LTVF-H40038BAA			
Hx2000	LTVF-H40045BAA	FR6	LTFM-FR6-H	FLANGE FOR LTVF-H40045~0061BAA
	LTVF-H40061BAA			
Hx2000	LTVF-H40075BAA	FR7	LTFM-FR7-H	FLANGE FOR LTVF-H40075BAA
Hx2000	LTVF-H40091BAA	FR8	LTFM-FR8-H	FLANGE FOR LTVF-H40091~0107BAA
	LTVF-H40107BAA			
Hx2000	LTVF-H40142BAA	FR9	LTFM-FR9-H	FLANGE FOR LTVF-H40142~0169BAA
	LTVF-H40169BAA			

Peripheral Devices

DBU & DBR Selection Chart for Nx2000+, Sx2000 & Fx2000

Inverter Capacity (1)	Motor kW (HD)	Dynamic Braking Unit		Specifications of the Breaking Resistor when ED is 5%		Specifications for Crane / Hoist *(2)	
		DBU Cat. No.	Qty	Resistor [Ω]	Qty	Resistor [Ω]	Qty
LTVF-N402P0BAA	0.4	Built-in		1200 Ω - 100 W	1	-	-
LTVF-S40002BAA				1200 Ω - 100 W	1	-	-
LTVF-N403P1BAA	0.75			600 Ω - 150 W	1	-	-
LTVF-S40003BAA				600 Ω - 150 W	1	600 Ω - 450 W	1
LTVF-F40004CAA	1.5			600 Ω - 150 W	1	600 Ω - 450 W	1
LTVF-N405P1BAA				300 Ω - 300 W	1	-	-
LTVF-S40005BAA	2.2			300 Ω - 300 W	1	300 Ω - 900 W	1
LTVF-F40006CAA				300 Ω - 300 W	1	300 Ω - 900 W	1
LTVF-N406P9BAA	3.7			200 Ω - 400 W	1	-	-
LTVF-S40007BAA				200 Ω - 400 W	1	200 Ω - 1200 W	1
LTVF-F40008CAA	4			200 Ω - 400 W	1	200 Ω - 1200 W	1
LTVF-N410P0BAA				130 Ω - 600 W	1	-	-
LTVF-S40010BAA	5.5			130 Ω - 600 W	1	130 Ω - 2000 W	1
LTVF-N416P0BAA				85 Ω - 1000 W	1	-	-
LTVF-S40016BAA	7.5			85 Ω - 1000 W	1	85 Ω - 3000 W	1
LTVF-F40016CAA				85 Ω - 1000 W	1	85 Ω - 3000 W	1
LTVF-N423P0BAA	11			60 Ω - 1200 W	1	-	-
LTVF-S40023BAA				60 Ω - 1200 W	1	60 Ω - 4000 W	1
LTVF-F40024CAA	15			60 Ω - 1200 W	1	60 Ω - 4000 W	1
LTVF-S40030BAA				40 Ω - 2000 W	1	40 Ω - 6000 W	1
LTVF-F40030CAA	18.5	40 Ω - 2000 W	1	40 Ω - 6000 W	1		
LTVF-S40038BAA		30 Ω - 2400 W	1	30 Ω - 8000 W	1		
LTVF-F40039CAA	22	30 Ω - 2400 W	1	30 Ω - 8000 W	1		
LTVF-S40044BAA		20 Ω - 3600 W	1	20 Ω - 10000 W	1		
LTVF-F40045CAA	30	20 Ω - 3600 W	1	20 Ω - 10000 W	1		
LTVF-S40058BAA		20 Ω - 3600 W	1	20 Ω - 12000 W	1		
LTVF-F40061CAA	37	20 Ω - 3600 W	1	20 Ω - 12000 W	1		
LTVF-S40075BAA		LTDBU-0370-4	1	16.9 Ω - 5000 W	1	16.9 Ω - 17000 W	1
LTVF-F40075CAA	45	LTDBU-0370-4	1	16.9 Ω - 5000 W	1	16.9 Ω - 17000 W	1
LTVF-S40091BAA		LTDBU-0370-4	1	16.9 Ω - 5000 W	1	16.9 Ω - 20000 W	1
LTVF-F40091CAA	55	LTDBU-0370-4	1	16.9 Ω - 5000 W	1	16.9 Ω - 20000 W	1
LTVF-S40107BAA		LTDBU-0550-4	1	11.4 Ω - 10000 W	1	11.4 Ω - 25000 W	1
LTVF-F40110CAA	75	LTDBU-0550-4	1	11.4 Ω - 10000 W	1	11.4 Ω - 25000 W	1
LTVF-S40142BAA		LTDBU-0550-4	1	11.4 Ω - 10000 W	1	11.4 Ω - 30000 W	1
LTVF-F40152CAA	90	LTDBU-0550-4	1	11.4 Ω - 10000 W	1	11.4 Ω - 30000 W	1
LTVF-S40169BAA		LTDBU-0750-4	1	8.4 Ω - 10000 W	1	8.4 Ω - 41000 W	1
LTVF-F40183CAA	110	LTDBU-0750-4	1	8.4 Ω - 10000 W	1	8.4 Ω - 41000 W	1
LTVF-S40223AAA		LTDBU-0550-4	2	11.4 Ω - 15000 W	2	11.4 Ω - 25000 W	2
LTVF-F40264AAA	132	LTDBU-0750-4	2	8.4 Ω - 17000 W	2	8.4 Ω - 30000 W	2
LTVF-S40325AAA		LTDBU-0750-4	2	8.4 Ω - 20000 W	2	8.4 Ω - 36000 W	2
LTVF-F40370AAA	160	LTDBU-2200-4	1	2 Ω - 25000 W	1	2 Ω - 96000 W	1
LTVF-S40432AAA		LTDBU-2200-4	1	2 Ω - 30000 W	1	2 Ω - 111000 W	1
LTVF-F40547AAA	185	LTDBU-2200-4	1	2 Ω - 30000 W	1	2 Ω - 132000 W	1
LTVF-S40613AAA		LTDBU-2200-4	2	2 Ω - 40000 W	2	2 Ω - 84000 W	2
LTVF-F40731AAA	220	LTDBU-2200-4	2	2 Ω - 60000 W	2	2 Ω - 95000 W	2
LTVF-S40877AAA		LTDBU-2200-4	2	2 Ω - 60000 W	2	2 Ω - 113000 W	2

Note: 1) DBR rating for Single-Phase 230Vac drive & Three-Phase 230V drive, contact nearest branch office. *(2) Above DBR chart is for Crane/ Hoist Applications
 3) DBU shall be purchased from E&A however DBR of given values must be purchased from local vendors. 4) For Elevator please contact nearest branch office.

Peripheral Devices

Incomer (MPCB / MCCB) & Magnetic Contactor (MC)

Drive kW (HD)	Specification of Breaker (MPCB / MCCB)				Magnetic Contactor (MC)			
	Heavy Duty		Normal Duty		Heavy Duty		Normal Duty	
	Type	A	Type	A	Type	A	Type	A
0.75	MOG-S1/MOG-H1	2.5 - 4	MOG-S1/MOG-H1	4 - 6.3	MO	9	MO	9
1.5	MOG-S1/MOG-H1	4 - 6.3	MOG-S1/MOG-H1	6.3 - 10	MO	9	MO	9
2.2	MOG-S1/MOG-H1	6.3 - 10	MOG-S1/MOG-H1	6.3 - 10	MO	9	MO	9
3.7	MOG-S1/MOG-H1	6.3 - 10	MOG-H1	11.0 - 16.0	MO	9	MO	18
5.5	MOG-H1	11.0 - 16.0	MOG-H1	14 - 20	MO	18	MO	18
7.5	MOG-H1	14 - 20	MOG-H1	24 - 32	MO	18	MO	25
11	MOG-H1	24 - 32	MOG-H2	28 - 40	MO	25	MO	40
15	MOG-H2	28 - 40	MOG-H2	35 - 50	MO	40	MO	45
18.5	MOG-H2	35 - 50	MOG-H2	45 - 63	MO	45	MO	50
22	MOG-H2	45 - 63	DN0 - 100M	80	MO	50	MO	60/70
30	DN0 - 100M	80	DN0 - 100M	100	MO	60/70	MO	80
37	DN0 - 100M	100	DN1 - 160M	125	MO	80	MO	110
45	DN1 - 160M	125	DN1 - 160M	160	MO	110	MO	140
55	DN1 - 160M	160	DN2 - 250M	200	MO	140	MO	185
75	DN2 - 250M	200	DN2 - 250M	250	MO	185	MO	225
90	DN2 - 250M	250	DN3 - 400M	320	MO	225	MO	250
110	DN3 - 400M	320	DN3 - 400M	400	MO	250	MO	300
132	DN3 - 400M	400	DN3 - 630M	500	MO	300	MNX	400
160	DN3 - 630M	500	DN3 - 630M	500	MNX	400	MNX	550
185	DN3 - 630M	500	DN3 - 630M	630	MNX	550	MNX	550
220	DN3 - 630M	630	DN4 - 1250N	320-800	MNX	550	MNX	650
280	DN4 - 1250N	320-800	DN4 - 1250N	400-1000	MNX	650	MNX*	400*
315	DN4 - 1250N	400-1000	DN4 - 1250N	500-1250	MNX*	400*	MNX*	550*
375	DN4 - 1250N	500-1250	DN4 - 1250N	500-1250	MNX*	550*	MNX*	550*

Note:

- 1) MC (Magnetic Contactor) current is 1.3 ~ 1.5 times of Drives rated current
- 2) MCCB should be used to protect against overload and damage of drive installation from the fault current.
- 3) From 22kW to 220kW MCCB dsine with frame size DN0 to DN3 with thermal-magnetic realease
& for above 220 kW MCCB dsine with frame DN4 - 1250N is used with MTX1.0 release.
- 4) *2 contactors are used in parallel

Peripheral Devices

Selection Chart for Input and Output Choke

Drive kW (ND)	Drive Current (A)		Chokes		
	Normal Duty	Heavy Duty	I/P AC Choke mH/A	DC Choke mH/A	O/P Choke mH/A
0.75	2	1.3	4.81 /4.8	16/4.27	8.1/3
1.1	3.1	2.5	4.81 /4.8	16/4.27	6.54/4.2
1.5	4	2.5	4.81 /4.8	16/4.27	6.54/5
2.2	6	4	3.23/7.5	12/6.41	3.71/7
3	6.9	5.5	3.23/7.5	12/6.41	2.45/8
3.7	8	6	2.34/10	8/8.9	2.45/9
4	10	8	1.22/15	5.4/13.2	1.9/12
5.5	12	8	1.22/15	5.34/14	1.9/12
7.5	16	12	1.22/18	3.2/17	1.1/18
11	24	16	0.78/27	2.5/25	0.81/25
15	30	24	0.59/35	1.9/32	0.54/35
18.5	39	30	0.46/44	1.4/41	0.45/40
22	45	39	0.4/52	1.0/49	0.36/46
30	61	45	0.3/68	0.7/64	0.29/62
37	75	61	0.232/98	Built-in	0.23/78
45	91	75	0.195/118		0.2/95
55	110	91	0.157/142		0.16/115
75	152	110	0.122/196		0.12/160
90	183	152	0.096/237		0.12/190
110	223	183	0.081/289		0.077/230
132	264	223	0.069/341		0.067/270
160	325	264	0.057/420		0.050/330
185	370	325	0.042/558		0.045/380
220	432	370	0.042/558		0.034/475
280	547	432	0.029/799	0.033/600	
315	613	547	0.029/799	0.09/836	0.031/630
375	731	613	0.024/952	0.076/996	0.031/800
450	877	731	0.024/952	0.064/1195	0.028/930

Device	Purpose	Details
MCCB or MPCB	To protect inverter wiring	Always install the MCCB or MPCB on the power supply side to protect the inverter from Short Circuit & Overload protection
Magnetic Contactor	For Isolation	Used at Input side to provide complete isolation when drive is switched off thus protecting the internal components. Also used for preventing burning of braking resistor with thermal feedback
Input AC or DC Reactor	To improve Inverter Power Factor	Use for further improving the power factor of the inverter by suppressing the harmonics from the power supply
Output Reactor	To avoid nuisance tripping of inverter	To avoid nuisance tripping of inverter due to leakage current caused because of the capacitive effect in longer cables between inverter & motor
Braking Resistor	To stop the machine within the preset time	Shortens the deceleration time by consuming the regenerative energy of the motor by the resistor
Braking Unit		Used in combination with the braking resistor to reduce the deceleration time of the motor

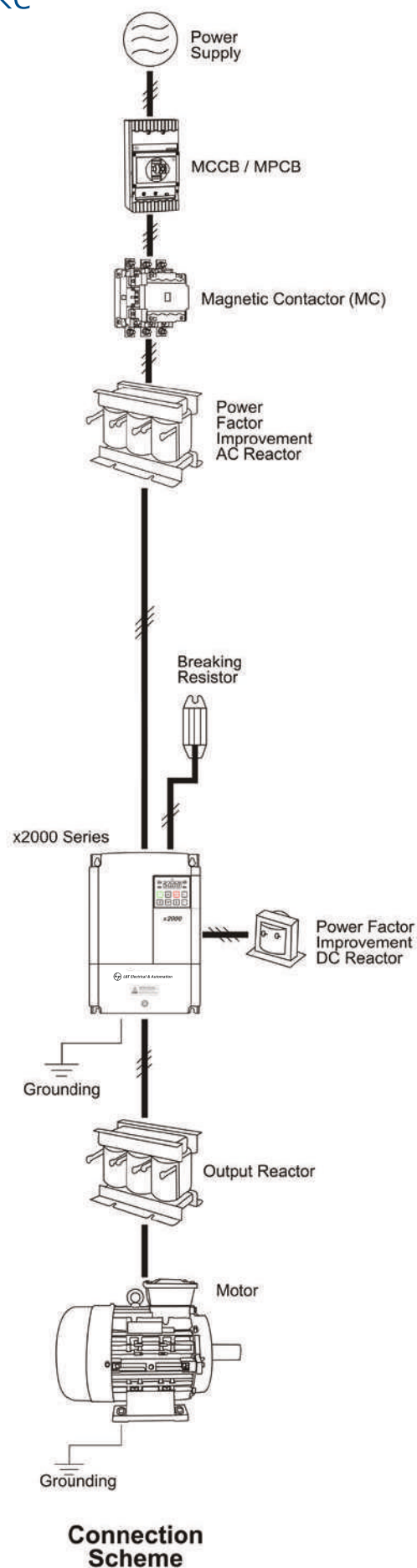

Other Automation Products

Soft Starter: Standard Applications

CSX & CSXi

Feature:

- Built-in bypass contactor
- Soft start / soft stop / adjustable current limit
- Essential motor protections against:
 - Overload & single phasing
 - Instantaneous overcurrent
 - Phase sequence reversal
 - Abnormality in supply
 - Unbalanced current
- Thermistor protection through PTC
- Excess start time setting
- Communication and PC Interface options available

Range: 7.5 to 110kW



Soft Starter

EMX4e

Features:

- Built in bypass contactor
- Compact & Flexible Design
- Screw-less design for easy and fast servicing
- USB port for easy and fast commissioning and data extraction
- Full graphical display with multi-languages support
- Built-in Simulation Mode
- 384 event logs
- Communication options available
- Fire Mode function available
- Starts per hour counter

Applications:

Centrifugal pumps, fans, conveyors, crusher, etc.

Range: 24A to 580A



Other Automation Products



Soft Starter EMX4i

Features:

- Built in bypass contactor
- Compact & Flexible Design
- Screw-less design for easy and fast servicing
- USB port for easy and fast commissioning and data extraction
- Full graphical display with multi-languages support
- Real time graphs of motor operating performance
- 384 event logs
- Advanced protection system
- Communication options available
- Smart card for level controlled pump activation and pump protection
- Under voltage/ Over voltage protection
- Starts per hour counter
- Fire Mode function available
- Power through function available

Applications:

Centrifugal pumps, fans, conveyors, crusher, etc.

Range: 24A to 1250A



HMI

Features:

- Large Memory: Upto 128MB display and 1MB back-up
- Various Communication Interface: Ethernet / RS-232C / 485
- USB host and device, SD memory card interface
- Web server / Data Monitoring, Remote controlling and monitoring
- Presence sensor (within 1m), Sound Output

Range: Text Display & 4" to 15" TFT color LCD

Other Automation Products

PLC

Features:

- Processing speed: 0.06 μ s/step
- Built-in Function: RTC, HSC, PTO, PID, Interrupt, Analog I/O
- Various communication Interface: Built-in USB / RS-232C / 485 / Ethernet, optional other communication modules
- Built-in Web-server, Email
- EtherCAT based motion control modules with Virtual Axis
- Built-in SD Card interface & Smart Remote I/O

Range: Upto 352 local I/O, Upto 5728 remote I/O points



SERVO

Features:

- Absolute encoder (standard)
- 1.6 kHz Frequency response
- Serial communication (RS-422 / 485, Modbus)
- Supports various operation modes (CSP, CSV, CST, PP, PV, PT, HM, IP, etc)
- Safe-torque off function, 4-step notch filter
- 2-step vibration suppression filter at the load position
- Voltage: 200Vac / 400Vac
- Speed: 1500rpm / 3000rpm
- Control: Pulse / Analog or Network

Range: 0.1kW to 15kW



Detuned Reactors

Features:

- Copper and Aluminum wound reactors
- Lower operating losses – 3 to 5 W/kVAR
- High linearity - 1.8 times the rated current, 200% linearity also available on request.
- With in-built thermal cut off

Range: 5 kVAR to 100 kVAR



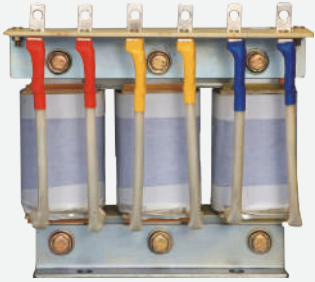

High V-THD Reactors

Features:

- Operates at safer temperature. It will not overheat due to high V-THD%.
- Lower Power loss and doesn't make humming noise.
- Mitigates significant current harmonic amplification & resonance.
- Avoids capacitor over-loading
- AHF rating can be optimized

Range: 5 kVAr to 100 kVAr

Power Factor Correction Capacitors

Features:

- Available in Standard Duty, Heavy Duty, Super Heavy Duty and Ultra Heavy Duty Capacitors
- Safety Features – Over pressure disconnecter, self-healing, finger-proof terminals
- Operating losses – less than 0.45 W/kVAr
- Ultra-Heavy Duty Capacitors with Max ambient temperature up to 70°C
- Ultra-Heavy Duty Capacitors with operating life up to 3 lakh hours

Range: up to 50kVAr, 440V, 480V and 525V



etaSYS Standard APFC Panels

Features:

- Covers the typical requirement of APFC panel ratings
- Offers optimal step resolution which would be suitable to all types of industries/buildings
- Pre-selected switchgear with accurate ratings offers reliable operation, protection and isolation
- Accurate combination of capacitor and reactor offers better protection against harmonics
- IP42 panels

Range: 20 to 500 kVAr



Active Harmonic Filters

Features:

- Mitigates 2nd to 50th order Harmonics
- Reduces THD within IEEE limits
- Improves power factor
- Load balancing and neutral current reduction
- Any number of units can be connected in parallel
- 7 inch TFT touch screen for monitoring and diagnostics
- Modular design for easy maintenance and upgradation
- Various alarms for easy diagnostics

Range: 30A to 800A in 3-Ph 3-W and up to 300A in 3-Ph 4-W versions



Hybrid Power Factor Correction Panel

Features:

- Fully Automatic in Operation
- Can be used to achieve consistently high Power Factor under fluctuating load
- Help in achieving True Power factor close to unity
- Mitigates harmonics in any Industry
- Minimises the total kVA_r consumption of the industry
- Reduces kVA demand charges
- Lower energy consumption in the installation by reducing losses
- Prevents leading power factor in an installation
- Elimination of low power factor penalty levied by electrical supply authorities

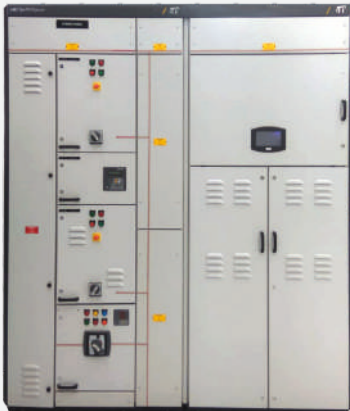

Multifunction Meters

Features:

- Available with multiple parameters including Basic, Power, Energy, THD, Max Demand, Import-Export
- Four row LED and LCD versions
- Accuracy Class 1, 0.5, 0.5S, 0.2, 0.2S
- Site selectable for 3-Ph 4-W, 3-Ph 3-W, 1-Ph
- Data logging provision
- Individual harmonics for voltage and current available up to 31st harmonics
- Analog and digital inputs and outputs available
- Time-of-day provision
- RS-485, Ethernet option
- MD controller with 4 relay outputs for proper load control





SmartComm Energy Management Solution

Features:

- Glimpse of entire energy consumption in the plant on a dashboard
- Quick understanding of energy consumption of today compared to yesterday, this month consumption compared to last month as well as Y-o-Y energy comparison
- Easy navigation through the modules
- All parameters in the device can be monitored from the software
- Multiple combination of devices and parameters for analysis
- Various spreadsheet reports with charts
- Specific energy consumption report
- Access to features defined by user levels
- E&A meters preconfigured in the software
- Provision for auto emails and SMS
- Provision for Breaker status monitoring of ON, OFF, TRIP and RTC status along with control through UNCO module.
- Web view
- On Premise and cloud based solution

SmartComm Integrated Solution

Features:

- Real-time communication for Monitoring, Control & Diagnostics.
 - Single platform integrating entire range of E&A communicable products with option of integrating third party products
 - Supports multiple protocols and drivers like Modbus TCP/IP, Modbus RTU, BACnet, IEC 61850, DeviceNet, Profibus & ProfiNet
 - Customised SLD Creation by user based on IEC 617-2-8 symbol library
 - Graphical or mimic view for enabling operator level users to understand reports easily
 - Real-time & historical trends for user-selectable parameters
 - Fully customized reports with user-created templates
 - System provides various alarms & events – alerts & acknowledgement
 - Email/SMS facility for predetermined events/schedules/alarms user management.
- Energy analytics dashboard, alerts and report.

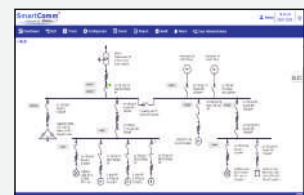

Electrical Standard Products (ESP) Offices:

HEAD OFFICE

L&T Electrical & Automation
L&T Business Park, TC 2, Tower 'B'
3rd Floor, Gate No 5
Saki Vihar Road, Powai
Mumbai 400 072
Tel: 022-67052874 / 2737 / 1156
e-mail: cic@LNTEBG.com

BRANCH OFFICES

L&T Electrical & Automation
501, Sakar Complex I
Opp. Gandhigram Rly. Station
Ashram Road
Ahmedabad 380 009
Tel: 079 4900 4000 / 4010
e-mail: esp-ahm@LNTEBG.com

L&T Electrical & Automation
No 38, Cubbon Road
Bengaluru 560 001
Tel: 080-46136103 / 100
e-mail: esp-blr@LNTEBG.com

L&T Electrical & Automation
131/1, Zone II, Maharana Pratap Nagar
Bhopal 462 011
e-mail: esp-bho@LNTEBG.com

L&T Electrical & Automation
Plot No. 559, Annapurna Complex, 2nd Floor
Lewis Road
Bhubaneswar 751 014
Tel: 0674-2436690 / 9437453579 / 9437284376
e-mail: esp-bsr@LNTEBG.com

L&T Electrical & Automation
Aspire Towers, 4th Floor
Plot No. 55, Phase-I
Industrial & Business Park
Chandigarh 160 002
Tel: 0172-4646840 / 41 / 42 / 44 / 53
e-mail: esp-chd@LNTEBG.COM

L&T Electrical & Automation
L&T Construction Campus
TC-1 Building, II Floor
Mount-Poonamallee Road
Manapakkam
Chennai 600 089
Tel: 044-2270 6800
e-mail: esp-maa1@LNTEBG.com

L&T Electrical & Automation
Building E3A, Manufacturing Facility
L&T Bypass Road, Malumichampatti
Coimbatore 641 050
Tel: 0422-6683031
e-mail: esp-cbe@LNTEBG.com

L&T Electrical & Automation
3rd Floor, 1&2 Vijay Park,
Main Chakrata road
Ballapur Chowk
Dehradun 248001
Tel: +91 9582252411

L&T Electrical & Automation
Khairasol, Degaul Avenue
Durgapur 713 212
Tel: 0343-2540448 / 2540449 / 2540443
e-mail: esp-dgp@LNTEBG.com

L&T Electrical & Automation
5, Milanpur Road, Bamuni Maidan
Guwahati 781 021
Tel: +91 8876554417
e-mail: esp-ghy@LNTEBG.com

L&T Electrical & Automation
2nd Floor, Vasantha Chambers
5-10-173, Fateh Maidan Road
Hyderabad 500 004
Tel: 040-67015052
e-mail: esp-hyd@LNTEBG.com

L&T Electrical & Automation
Monarch Building, 1st Floor
D-236 & 237, Amrapali Marg
Vaishali Nagar
Jaipur 302 021
Tel: 0141-4385914 to 18
e-mail: esp-jai@LNTEBG.com

L&T Electrical & Automation
Akashdeep Plaza, 2nd Floor
P. O. Golmuri
Jamshedpur 831 003
Jharkhand
Tel: 0657-2340502 / 08
e-mail: esp-jam@LNTEBG.com

L&T Electrical & Automation
Skybright Bldg; M. G. Road
Ravipuram Junction, Ernakulam
Kochi 682 016
Tel: 0484-4409420 / 4 / 5 / 7
e-mail: esp-cok@LNTEBG.com

L&T Electrical & Automation
3-B, Shakespeare Sarani
Kolkata 700 071
Tel: 033-48006001
e-mail: esp-kol@LNTEBG.com

L&T Electrical & Automation
No. 10, Fortuna Tower, 2nd Floor
Rana Pratap Marg, Near NBRI
Lucknow 226001
e-mail: esp-Lko@LNTEBG.com

L&T Electrical & Automation
No: 73, Karpaga Nagar, 8th Street
K. Pudur
Madurai 625007
Tel: 0452-2567405 / 2561068 / 2561657
e-mail: esp-mdu@LNTEBG.com

L&T Electrical & Automation
L&T Business Park, TC 2, Tower 'B'
3rd Floor, Gate No 5
Saki Vihar Road, Powai
Mumbai 400 072
Tel: 022-67052874 / 2737 / 1156
e-mail: esp-bom@LNTEBG.com

L&T Electrical & Automation
Unnati Building, 2nd Floor
Automation Campus
A-600, TTC Industrial area
Shil-Mahape road, Mahape
Navi Mumbai 400710
Tel: +91 22 67226502 / 67226300

L&T Electrical & Automation
12, Shivaji Nagar
North Ambajhari Road
Nagpur 440 010
Tel: 0712-2260012 / 6606421
e-mail: esp-nag@LNTEBG.com

L&T Electrical & Automation
32, Shivaji Marg,
Near Moti Nagar,
P. O. Box 6223
New Delhi 110 015
Tel: 011-41419514 / 5 / 6
e-mail: esp-del@LNTEBG.com

L&T Electrical & Automation
Grand Chandra, 2nd Floor
Fraser Road
Opposite Doordarshan Kendra
Patna 800001
e-mail: esp-patna@LNTEBG.com

L&T Electrical & Automation
L&T House
P. O. Box 119
191/1, Dhole Patil Road
Pune 411 001
Tel: 020-48544395 / 48544279
e-mail: esp.pnq@LNTEBG.com

L&T Electrical & Automation
Crystal Tower,
4th Floor, G. E. Road
Telibandha
Raipur 492 006
Tel: +91 9755508228
e-mail: esp-raipur@LNTEBG.com

L&T Electrical & Automation
3rd Floor
Vishwakarma Chambers
Majura Gate, Ring Road
Surat 395 002
Tel: 0261-2473726
e-mail: esp-sur@LNTEBG.com

L&T Electrical & Automation
Radhadaya Complex
Old Padra Road
Near Charotar Society
Vadodra 390 007
Tel: 0265-6613610 / 1 / 2
e-mail: esp-bar@LNTEBG.com

L&T Electrical & Automation
Door No. 49-38-14/3/2, 1st floor,
NGGO's Colony, Akkayapalem,
Visakhapatnam 530 016
Tel: 0891-2791126 / 2711125
e-mail: esp-viz@LNTEBG.com

Product improvement is a continuous process. For the latest information and special application, please contact any of our offices listed here. Product photographs shown for representative purpose only.



L&T Electrical & Automation, Electrical Standard Products

L&T Business Park, TC-2, Tower B, 3rd Floor, Gate No. 5, Saki Vihar Road, Powai,
Mumbai - 400 072, INDIA www.lntebg.com

Customer Interaction Center (CIC)

BSNL / MTNL (toll-free): 1800 233 5858 Reliance (toll-free): 1800 200 5858
Tel: 022 6774 5858 Email: cic@lntebg.com Web: www.lntebg.com